

OVERPASS AGREEMENT

BNSF File No. BF10016433
McKinley Street Overpass
U.S. D.O.T. No. 026519P
LS 7602
MP21.168
San Bernardino Subdivision

This Agreement ("**Agreement**"), is executed to be effective as of 6/24/2021 | 10:34:28 AM CDT ("**Effective Date**"), by and between BNSF RAILWAY COMPANY, a Delaware corporation ("**BNSF**"), and the CITY OF CORONA, a political subdivision of the State of California ("**Agency**").

RECITALS:

WHEREAS, BNSF owns and operates a line of railroad in and through the CITY OF CORONA, State of California;

WHEREAS, Agency desires to improve the existing McKinley Street at-grade crossing by constructing a new crossing at separated grades to be known as the McKinley Street Overpass, D.O.T. No. 026519P; and

WHEREAS, the existing McKinley Street at-grade crossing will be permanently closed, vacated and removed upon completion of construction and the placing in service of said overpass.

NOW, THEREFORE, in consideration of the mutual covenants and agreements of the parties contained herein, the receipt and sufficiency of which are hereby acknowledged, the parties agree as follows:

ARTICLE I) SCOPE OF WORK

1. The term "**Project**" as used herein includes any and all work related to the construction of the proposed McKinley Ave Overpass (hereinafter referred to as the "**Structure**"), more particularly described on the Exhibit A attached hereto and incorporated herein, including, but not limited to, any and all changes to telephone, telegraph, signal and electrical lines and appurtenances, temporary and permanent track work, fencing, grading, alterations to or new construction of drainage facilities, preliminary and construction engineering and contract

preparation. Additionally, temporary controls during construction must be in compliance with Section 8A-08, "Temporary Traffic Control Zones" of the Manual of Uniform Traffic Control Devices ("MUTCD"), U.S. Department of Transportation.

ARTICLE II) BNSF OBLIGATIONS

In consideration of the covenants of Agency set forth herein and the faithful performance thereof, BNSF agrees as follows:

1. Upon Agency's payment to BNSF of an administrative fee in the sum of Two Thousand **Five Hundred** and No/100 Dollars (**\$2,500**), together with the Temporary Construction License Fee in the sum of \$ One Hundred Forty Six Thousand Five Hundred Twenty-Eight and No/100 Dollars (**\$146,528.00**), BNSF hereby grants to Agency, its successors and assigns, upon and subject to the terms and conditions set forth in this Agreement, a temporary non-exclusive license (hereinafter called, "Temporary Construction License") to construct the Structure across or upon the portion of BNSF's right-of-way described further on Exhibit A-1, excepting and reserving BNSF's rights, and the rights of any others who have obtained, or may obtain, permission or authority from BNSF, to do the following:

- (a) Operate, maintain, renew and/or relocate any and all existing railroad track or tracks, wires, pipelines and other facilities of like character upon, over or under the surface of said right-of-way;
- (a) Construct, operate, maintain, renew and/or relocate upon said right-of-way, without limitation, such facilities as the BNSF may from time to time deem appropriate, provided such facilities do not materially interfere with the Agency's use of the Structure;
- (b) Otherwise use or operate the right-of-way as BNSF may from time to time deem appropriate, provided such use or operations does not materially interfere with the Agency's use of the Structure; and
- (c) Require the Agency or its contractor to execute a Temporary Construction Crossing Agreement, for any temporary crossing requested to aid in the construction of this Project.

The term of the Temporary Construction License begins on the Effective Date and ends on the earlier of (i) substantial completion of the Structure, or (ii) 36 months following the Effective Date. The Temporary Construction License and related rights given by BNSF to Agency in this provision are without warranty of title of any kind, express or implied, and no covenant of warranty of title will be implied from the use of any word or words herein contained. The Temporary Construction License is for construction of the Structure only and shall not be used by Agency for any other purpose. Agency acknowledges and agrees that Agency shall not have the right, under the Temporary Construction License, to use the Structure for any other purpose than construction. In the event Agency is evicted by anyone owning, or claiming title to or any interest in said right-of-way, BNSF will not be liable to Agency for any damages, losses or any expenses of any nature whatsoever. The granting of similar rights to others, subsequent to the date of this Agreement, will not impair or interfere with the rights granted to Agency herein.

Upon Agency's payment to BNSF of the additional sum of \$ Forty Five Thousand Five Hundred Seventeen and No/100 Dollars (\$45,517), such payment to be made within thirty (30) days of issuing the Notice to Proceed pursuant to Article III, Section 16 of this Agreement, and provided further that Agency is in compliance with the term and conditions of this Agreement, BNSF will grant to Agency, its successors and assigns, an easement (hereinafter called, the "Easement") to enter upon and use that portion of BNSF's right-of-way as is necessary to use and maintain the Structure, substantially in the form of Exhibit B attached to this Agreement. If Agency fails to pay BNSF within the thirty day time period set forth in the preceding sentence, BNSF may stop construction of the Project until full payment is received by BNSF.

2. BNSF will furnish all labor, materials, tools, and equipment for railroad work required for the construction of the Project, such railroad work and the estimated cost thereof being as shown on Exhibit D attached hereto and made a part hereof. In the event construction on the Project has not commenced within six (6) months following the Effective Date, BNSF may, in its sole and absolute discretion, revise the cost estimates set forth in said Exhibit D. In such event, the revised cost estimates will become a part of this Agreement as though originally set forth herein. Any item of work incidental to the items listed on Exhibit D not specifically mentioned therein may be included as a part of this Agreement upon written approval of Agency, which approval will not be unreasonably withheld. Construction of the Project must include the following railroad work by BNSF:

- (a) Procurement of materials, equipment and supplies necessary for the railroad work;
- (b) Preliminary engineering, design, and contract preparation;

- (c) Furnishing of flagging services during construction of the Project as required and set forth in further detail on Exhibit C;
- (d) Furnishing engineering and inspection as required in connection with the construction of the Project;
- (e) Providing a contract project coordinator, at Agency's expense, to serve as a project manager for the Project;
- (f) If required, removal of the existing McKinley Street at-grade crossing, including removal of the automatic warning devices, and obliteration of the crossing between the rails and two feet outside thereof; and
- (g) If required, construction of a temporary pedestrian at-grade crossing and installation of automatic warning devices, at Agency's expense.

3. BNSF will do all railroad work set forth in Article II, Section 2 above on an actual cost basis, when BNSF, in its sole discretion, determines it is required by its labor agreements to perform such work with its own employees working under applicable collective bargaining agreements.

4. Agency agrees to reimburse BNSF for work of an emergency nature caused by Agency or Agency's contractor in connection with the Project which BNSF deems is reasonably necessary for the immediate restoration of railroad operations, or for the protection of persons or BNSF property. Such work may be performed by BNSF without prior approval of Agency and Agency agrees to fully reimburse BNSF for all such emergency work.

5. BNSF may charge Agency for insurance expenses, including self-insurance expenses, when such expenses cover the cost of Employer's Liability (including, without limitation, liability under the Federal Employer's Liability Act) in connection with the construction of the Project. Such charges will be considered part of the actual cost of the Project, regardless of the nature or amount of ultimate liability for injury, loss or death to BNSF's employees, if any, but are subject to any applicable limitations to the Agency's indemnity obligations provided in Article III, Section 16 below.

6. During the construction of the Project, BNSF will send Agency progressive invoices detailing the costs of the railroad work performed by BNSF under this Agreement. Agency must reimburse BNSF for completed force-account work within thirty (30) days of the date of the invoice for such work. Upon completion of the Project, BNSF will send Agency a detailed invoice of final costs, segregated as to labor and materials for each item in the recapitulation shown on Exhibit D. Pursuant to this section and Article IV, Section 7 herein, Agency must pay the final invoice within ninety (90) days of the date of the final invoice. BNSF will assess a finance charge of .033% per day (12% per annum) on any unpaid sums or other charges due under this Agreement which are past its credit terms. The finance charge continues to accrue daily until the date payment is received by BNSF, not the date payment is made or the date postmarked on the payment. Finance charges will be assessed on delinquent sums and other charges as of the end of the month and will be reduced by amounts in dispute and any unposted payments received by the month's end. Finance charges will be noted on invoices sent to Agency under this section. **For purposes of computing the time limits prescribed by Section 911.2 of the California Government Code for the presentment of a claim against the Agency the cause of action for failure to reimburse BNSF for the costs of the Railroad work performed by it pursuant to this Agreement shall be deemed to have accrued one hundred and eighty (180) days of the date of the final invoice.**

ARTICLE III) AGENCY OBLIGATIONS

In consideration of the covenants of BNSF set forth herein and the faithful performance thereof, Agency agrees as follows:

1. Agency must furnish to BNSF plans and specifications for the Project. One electronic set of said plans, together with one copy of calculations, and one copy of specifications in **English Units**, must be submitted to BNSF for acceptance prior to commencement of any construction. BNSF will give Agency final written acceptance of the plans and specifications. Upon BNSF's final written acceptance of the plans and specifications, said plans and specifications will become part of this Agreement and are hereby incorporated herein. Any acceptance of the plans and specifications by BNSF shall in no way obligate BNSF in any manner with respect to the finished product design and/or construction. Any acceptance by BNSF shall mean only that the plans and specifications meet the subjective standards of BNSF, and such acceptance by BNSF shall not be deemed to mean that the plans and specifications or construction is structurally sound and appropriate or that such plans and specifications meet applicable regulations, laws, statutes or local ordinances and/or building codes.

2. Agency must make any required application and obtain all required permits and approvals for the construction of the Project.

3. Agency must provide for and maintain minimum vertical and horizontal clearances, as required in Exhibit C and as approved by BNSF as part of the plans and specifications for the Project.

4. Agency must acquire all rights of way necessary for the construction of the Project.

5. Agency must make any and all arrangements, in compliance with BNSF's Utility Accommodation Manual (<http://www.bnsf.com/communities/faqs/pdf/utility.pdf>), for the installation or relocation of wire lines, pipe lines and other facilities owned by private persons, companies, corporations, political subdivisions or public utilities other than BNSF which may be necessary for the construction of the Project..

6. Agency must construct the Project as shown on the attached Exhibit A and do all work ("Agency's Work") provided for in the plans and specifications for the Project, except railroad work that will be performed by BNSF hereunder. Agency must furnish all labor, materials, tools and equipment for the performance of Agency's Work. The principal elements of Agency's Work are as follows:

(c) Construction of the Structure;

(b) All necessary grading and paving, including backfill of excavations and restoration of disturbed vegetation on BNSF's right-of-way;

(c) Provide suitable drainage, both temporary and permanent;

(d) Installation of a gate in the fence along the boundary of BNSF's right of way in order to provide BNSF with permanent access for maintenance purposes;

- (e) Temporary Installation of K-Rail (Jersey) barriers and chain link fencing along McKinley Street between the tracks and the traveled roadways;
- (f) Construction and removal of a temporary pedestrian roadway detour crossing of the tracks, including chain link fence;
- (g) Provide appropriate pedestrian control during construction;
- (h) Installation and maintenance of an 8-ft. high fence and/or concrete combination (throw fence) on the outside barrier of the Structure;
- (i) Job site cleanup including removal of all construction materials, concrete debris, surplus soil, refuse, contaminated soils, asphalt debris, litter and other waste materials to the satisfaction of BNSF;

7. Agency must apply and maintain said D.O.T. Crossing number 026519P, and the Public Utility Commission Crossing number 002B-21.20 in a conspicuous location on the Structure.

8. Agency's Work must be performed by Agency or Agency's contractor in a manner that will not endanger or interfere with the safe and timely operations of BNSF and its facilities.

9. For any future inspection or maintenance, either routine or otherwise, performed by subcontractors on behalf of the Agency, Agency shall require the subcontractors to comply with the provisions of the attached Exhibit C and execute the agreement attached hereto as Exhibit C-1. Prior to performing any future maintenance with its own personnel, Agency shall: comply with all of BNSF's applicable safety rules and regulations; require any Agency employee performing maintenance to complete the safety training program at the BNSF's Internet Website "www.BNSFContractor.com"; notify BNSF when, pursuant to the requirements of Exhibit C, a flagger is required to be present; procure, and have approved by BNSF's Risk Management Department, Railroad Protective Liability insurance.

10. Agency must require its contractor(s) to notify BNSF's Roadmaster at least thirty (30) calendar days prior to requesting a BNSF flagman in accordance with the requirements of Exhibit C attached hereto. Additionally, Agency must require its contractor(s) to notify BNSF's Manager of Public Projects thirty (30) calendar days prior to commencing work on BNSF property or near BNSF tracks.

11. Agency or its contractor(s) must submit one (1) electronic copy of plans (including one set of calculations in **English Units**) for proposed shoring, falsework or cribbing to be used over, under, or adjacent to BNSF's tracks to BNSF's Field Representative for acceptance. The shoring, falsework or cribbing used by Agency's contractor shall comply with the BNSF Requirements for construction of Grade Separation Projects set forth on Exhibit F and all applicable requirements promulgated by state and federal agencies, departments, commissions and other legislative bodies. If necessary, Agency must submit for acceptance one (1) electronic copy of a professionally engineered demolition plan, as set forth in Exhibit F – BNSF Process Requirements, with applicable calculations to BNSF's Field Representative.

12. Agency must include the following provisions in any contract with its contractor(s) performing work on said Project:

- (a) The Provider is placed on notice that fiber optic, communication and other cable lines and systems (collectively, the "Lines") owned by various telecommunications companies may be buried on BNSF's property or right-of-way. The locations of these Lines have been included on the plans based on information from the telecommunications companies. The Provider will be responsible for contacting BNSF's Engineering Representative, BNSF's Signal Representative, and the telecommunications companies and notifying them of any work that may damage these Lines or facilities and/or interfere with their service. The Provider must also mark all Lines shown on the plans or marked in the field in order to verify their locations. The Provider must also use all reasonable methods when working in the BNSF right-of-way or on BNSF property to determine if any other Lines (fiber optic, cable, communication or otherwise) may exist.
- (b) The Provider will be responsible for the rearrangement of any facilities or Lines determined to interfere with the construction. The Provider must cooperate fully with any telecommunications company(ies) in performing such rearrangements.
- (c) Failure to mark or identify these Lines will be sufficient cause for BNSF's engineering representative to stop construction at no cost to the Agency or BNSF until these items are completed.

- (d) In addition to the liability terms contained elsewhere in this Agreement, the Provider hereby indemnifies, defends and holds harmless BNSF for, from and against all cost, liability, and expense whatsoever (including, without limitation, attorney's fees and court costs and expenses) arising out of or in any way contributed to by any act or omission of Provider, its subcontractors, agents and/or employees that cause or in any way or degree contribute to (1) any damage to or destruction of any Lines by Provider, and/or its subcontractors, agents and/or employees, on BNSF's property or within BNSF's right-of-way, (2) any injury to or death of any person employed by or on behalf of any telecommunications company, and/or its contractor, agents and/or employees, on BNSF's property or within BNSF's right-of-way, and/or (3) any claim or cause of action for alleged loss of profits or revenue by, or loss of service by a customer or user of such telecommunication company(ies). **THE LIABILITY ASSUMED BY PROVIDER WILL NOT BE AFFECTED BY THE FACT, IF IT IS A FACT, THAT THE DAMAGE, DESTRUCTION, INJURY, DEATH, CAUSE OF ACTION OR CLAIM WAS OCCASIONED BY OR CONTRIBUTED TO BY THE NEGLIGENCE OF BNSF, ITS AGENTS, SERVANTS, EMPLOYEES OR OTHERWISE, EXCEPT TO THE EXTENT THAT SUCH CLAIMS ARE PROXIMATELY CAUSED BY THE WILLFUL MISCONDUCT OR SOLE NEGLIGENCE OF BNSF.**

13. Agency must require compliance with the obligations set forth in this agreement, including Exhibit C and Exhibit C-1, and incorporate in each prime contract for construction of the Project, or the specifications therefor (i) the provisions set forth in Article III and IV; and (ii) the provisions set forth in Exhibit C, Exhibit C-1, and Exhibit F attached hereto and by reference made a part hereof.

14. Except as otherwise provided below in this Section 13, all construction work performed hereunder by Agency for the Project will be pursuant to a contract or contracts to be let by Agency, and all such contracts must include the following:

- (d) All work performed under such contract or contracts within the limits of BNSF's right-of-way must be performed in a good and workmanlike manner in accordance with plans and specifications approved by BNSF;
- (e) Changes or modifications during construction that affect safety or BNSF operations must be subject to BNSF's acceptance;
- (f) No work will be commenced within BNSF's right-of-way until each of the prime contractors employed in connection with said work must have (i) executed and delivered to BNSF an agreement in the form of Exhibit C-1, and (ii) delivered to and secured BNSF's approval of the required insurance; and

- (g) To facilitate scheduling for the Project, Agency shall have its contractor give BNSF's representative four (4) weeks advance notice of the proposed times and dates for work windows. BNSF and Agency's contractor will establish mutually agreeable work windows for the Project. BNSF has the right at any time to revise or change the work windows, due to train operations or service obligations. BNSF will not be responsible for any additional costs and expenses resulting from a change in work windows. Additional costs and expenses resulting from a change in work windows shall be accounted for in the contractor's expenses for the Project.

- (h) The plans and specifications for the Project must be in compliance with the BNSF Requirements for construction of Grade Separation Projects set forth on Exhibit F, attached to this Agreement and incorporated herein.

15. Agency must advise the appropriate BNSF Manager of Public Projects, in writing, of the completion date of the Project within thirty (30) days after such completion date. Additionally, Agency must notify BNSF's Manager of Public Projects, in writing, of the date on which Agency and/or its Contractor will meet with BNSF for the purpose of making final inspection of the Project.

16. **TO THE FULLEST EXTENT PERMITTED BY LAW, AGENCY HEREBY RELEASES, INDEMNIFIES, DEFENDS AND HOLDS HARMLESS BNSF, ITS AFFILIATED COMPANIES, PARTNERS, SUCCESSORS, ASSIGNS, LEGAL REPRESENTATIVES, OFFICERS, DIRECTORS, SHAREHOLDERS, EMPLOYEES AND AGENTS FOR, FROM AND AGAINST ANY AND ALL CLAIMS, LIABILITIES, FINES, PENALTIES, COSTS, DAMAGES, LOSSES, LIENS, CAUSES OF ACTION, SUITS, DEMANDS, JUDGMENTS AND EXPENSES (INCLUDING, WITHOUT LIMITATION, COURT COSTS AND ATTORNEYS' FEES) OF ANY NATURE, KIND OR DESCRIPTION OF ANY PERSON (INCLUDING, WITHOUT LIMITATION, THE EMPLOYEES OF THE PARTIES HERETO) OR ENTITY DIRECTLY OR INDIRECTLY ARISING OUT OF, RESULTING FROM OR RELATED TO (IN WHOLE OR IN PART) (I) THE USE, OCCUPANCY OR PRESENCE OF AGENCY, ITS CONTRACTORS, SUBCONTRACTORS, EMPLOYEES OR AGENTS IN, ON, OR ABOUT THE CONSTRUCTION SITE, (II) THE PERFORMANCE, OR FAILURE TO PERFORM BY THE AGENCY, ITS CONTRACTORS, SUBCONTRACTORS, EMPLOYEES, OR AGENTS, ITS WORK OR ANY OBLIGATION UNDER THIS AGREEMENT, (III) THE SOLE OR CONTRIBUTING ACTS OR OMISSIONS OF AGENCY, ITS CONTRACTORS, SUBCONTRACTORS, EMPLOYEES, OR AGENTS IN, ON, OR ABOUT THE CONSTRUCTION SITE, (IV) AGENCY'S BREACH OF THE TEMPORARY CONSTRUCTION LICENSE OR EASEMENT GRANTED TO AGENCY PURSUANT TO ARTICLE II OF THIS AGREEMENT, (V) ANY RIGHTS OR INTERESTS GRANTED TO AGENCY PURSUANT TO THE TEMPORARY CONSTRUCTION LICENSE OR EASEMENT DISCUSSED IN ARTICLE II OF THIS AGREEMENT, (VI) AGENCY'S OCCUPATION AND USE OF BNSF'S PROPERTY OR RIGHT-OF-WAY, INCLUDING,**

WITHOUT LIMITATION, SUBSEQUENT MAINTENANCE OF THE STRUCTURE BY AGENCY, OR (VII) AN ACT OR OMISSION OF AGENCY OR ITS OFFICERS, AGENTS, INVITEES, EMPLOYEES OR CONTRACTORS OR ANYONE DIRECTLY OR INDIRECTLY EMPLOYED BY ANY OF THEM, OR ANYONE THEY CONTROL OR EXERCISE CONTROL OVER. THE LIABILITY ASSUMED BY AGENCY WILL NOT BE AFFECTED BY THE FACT, IF IT IS A FACT, THAT THE DAMAGE, DESTRUCTION, INJURY OR DEATH WAS OCCASIONED BY OR CONTRIBUTED TO BY THE NEGLIGENCE OF BNSF, ITS AGENTS, SERVANTS, EMPLOYEES OR OTHERWISE, EXCEPT TO THE EXTENT THAT SUCH CLAIMS ARE PROXIMATELY CAUSED BY THE WILLFUL MISCONDUCT OR SOLE NEGLIGENCE OF BNSF.

17. Agency must give BNSF's Manager of Public Projects written notice to proceed ("**Notice to Proceed**") with the railroad work after receipt of necessary funds for the Project. BNSF will not begin the railroad work (including, without limitation, procurement of supplies, equipment or materials) until written notice to proceed is received from Agency.

18. Agency must perform all necessary work to obtain the permanent closure and vacation of McKinley Street across BNSF's right-of-way and must barricade the road approaches prior to completion of the Project. BNSF will cooperate with Agency to achieve the closure and vacation of McKinley Street and will remove the crossing surface within its right-of-way.

ARTICLE IV) JOINT OBLIGATIONS

IN CONSIDERATION of the premises, the parties hereto mutually agree to the following:

1. All work contemplated in this Agreement must be performed in a good and workmanlike manner and each portion must be promptly commenced by the party obligated hereunder to perform the same and thereafter diligently prosecuted to conclusion in its logical order and sequence. Furthermore, any changes or modifications during construction which affect BNSF will be subject to BNSF's written acceptance prior to the commencement of any such changes or modifications from the Manager of Public Projects.

2. The work hereunder must be done in accordance with the BNSF Requirements for construction of Grade Separation Projects set forth on Exhibit F and the detailed plans and specifications approved by BNSF.

3. Agency must require its contractor(s) to reasonably adhere to the Project's construction schedule for all Project work. The parties hereto mutually agree that BNSF's failure to complete the railroad work in accordance with the construction schedule due to inclement weather or unforeseen railroad emergencies will not constitute a breach of this Agreement by BNSF and will not subject BNSF to any liability. Regardless of the requirements of the construction schedule, BNSF reserves the right to reallocate the labor forces assigned to complete the railroad work in the event of an emergency to provide for the immediate restoration of railroad operations of either (BNSF or its related railroads) or to protect persons or property on or near any BNSF owned property. BNSF will not be liable for any additional costs or expenses resulting from any such reallocation of its labor forces. The parties mutually agree that any reallocation of labor forces by BNSF pursuant to this provision and any direct or indirect consequences or costs resulting from any such reallocation will not constitute a breach of this Agreement by BNSF.

4. BNSF will have the right to stop construction work on the Project if any of the following events take place: (i) Agency (or any of its contractors) performs the Project work in a manner contrary to the plans and specifications approved by BNSF; (ii) Agency (or any of its contractors), in BNSF's opinion, prosecutes the Project work in a manner that is hazardous to BNSF property, facilities or the safe and expeditious movement of railroad traffic; (iii) the insurance described in the attached Exhibit C-1 is canceled during the course of the Project; or (iv) Agency fails to pay BNSF for the Temporary Construction License or the Easement pursuant to Article II, Section 1 of this Agreement. The work stoppage will continue until all necessary actions are taken by Agency or its contractor to rectify the situation to the satisfaction of BNSF's Division Engineer or until proof of additional insurance has been delivered to and accepted by BNSF. In the event of a breach of (i) this Agreement, (ii) the Temporary Construction License, or (iii) the Easement, BNSF may immediately terminate the Temporary Construction License or the Easement. Any such work stoppage under this provision will not give rise to any liability on the part of BNSF. BNSF's right to stop the work is in addition to any other rights BNSF may have including, but not limited to, actions or suits for damages or lost profits. In the event that BNSF desires to stop construction work on the Project, BNSF agrees to immediately notify the following individual in writing:

5. Agency must supervise and inspect the operations of all Agency contractors to ensure compliance with the plans and specifications approved by BNSF, the terms of this Agreement and all safety requirements of BNSF. If BNSF determines that proper supervision and inspection are not being performed by Agency personnel at any time during construction of the Project, BNSF has the right to stop construction (within or adjacent to its operating right-of-way). Construction of the Project will not proceed until Agency corrects the situation to BNSF's reasonable satisfaction. If BNSF feels the situation is not being corrected in an expeditious manner, BNSF will immediately notify for appropriate corrective action.

6. BNSF will contribute a not to exceed amount of Three Million and Eight Hundred and Ten Thousand and No/100 Dollars \$3,810,000 (**hereinafter referred to as "BNSF's Share"**) towards the total actual costs of the Project. BNSF's Share will be based on the costs for preliminary engineering, right-of-way and construction within the following limits;

- (a) Where a grade crossing is eliminated by grade separation, the structure and approaches required to transition to a theoretical highway profile which would have been constructed if there were no railroad present, for the number of lanes on the existing highway and in accordance with the current design standards of the appropriate state highway agency; and
- (b) Where another facility, such as a highway or waterway, requiring a bridge structure is located within the limits of a grade separation project, the estimated cost of a theoretical structure and approaches as described in 23 CFR 646.210(c)(1) to eliminate the railroad-highway grade crossing without considering the presence of the waterway or other highway.

Additionally, local and state funds will be used in the construction of the Project. The total actual cost of construction for the Project is presently estimated to be \$111,000,000 more particularly described (together with BNSF's Share) on Exhibit G attached hereto and incorporated herein.

7. Pursuant to this section and Article II, Section 6 herein, Agency must reimburse BNSF in full for the actual costs of all work performed by BNSF under this Agreement (including taxes, such as applicable sales and use taxes, business and occupation taxes, and similar taxes), less BNSF's Share as set forth in Article IV, Section 6 herein. BNSF's Share must be paid upon completion of the Project.

In any action brought under this Agreement, the prevailing Party shall be entitled to recover its actual costs and attorneys fees pursuant to California Civil Code Section 1717, as well as other litigation costs, including expert witness fees. The prevailing Party shall also be entitled to recover all actual attorneys fees and litigation costs incurred in connection with the enforcement of a judgment arising from such action or proceeding.

8. All expenses detailed in statements sent to Agency pursuant to Article II, Section 6 herein will comply with the terms and provisions of the Title 23 U.S. Code, Title 23 Code of Federal Regulations, and the Federal-Aid Policy Guide, U.S. Department of Transportation, as amended from time to time, which manual is hereby incorporated into and made a part of this Agreement by reference. The parties mutually agree that BNSF's preliminary engineering, design, and contract preparation costs described in Article II, Section 2 herein are part of the costs of the Project even though such work may have preceded the date of this Agreement.

9. The parties mutually agree that neither construction activities for the Project, nor future maintenance of the Structure once completed, will be permitted during the fourth quarter of each calendar year. Emergency work will be permitted only upon prior notification to BNSF's Network Operations Center (telephone number: 800 832-5452). The parties hereto mutually understand and agree that trains cannot be subjected to delay during this time period.

10. Subject to the restrictions imposed by Article IV, Section 9 above, the construction of the Project will not commence until Agency gives BNSF's Manager of Public Projects thirty (30) days prior written notice of such commencement. The commencement notice will reference D.O.T. Crossing No. 026519P and must state the time that construction activities will begin.

11. In addition to the terms and conditions set forth elsewhere in this Agreement, including, but not limited to, the terms and conditions stated in Exhibit F, BNSF and Agency agree to the following terms upon completion of construction of the Project:

- (a) Agency will own and maintain, at its sole cost and expense, the Structure, the highway approaches, and appurtenances thereto, lighting, drainage and any access roadways to BNSF gates installed pursuant to this Agreement. BNSF may, at its option, perform maintenance on the Structure in order to avoid conflicts with train operations. BNSF will notify Agency prior to performing any such maintenance on the Structure. In the event such maintenance involves emergency repairs, BNSF will notify Agency at its earliest opportunity. Agency must fully

reimburse BNSF for the costs of maintenance performed by BNSF pursuant to this subsection

- (b) Agency must, at Agency's sole cost and expense, keep the Structure painted and free from graffiti.
- (c) Agency must provide BNSF with any and all necessary permits and maintain roadway traffic controls, at no cost to BNSF, whenever requested by BNSF to allow BNSF to inspect the Structure or to make emergency repairs thereto.
- (d) It is expressly understood by Agency and BNSF that any right to install utilities will be governed by a separate permit or license agreement between the parties hereto.
- (e) Agency must keep the Structure and surrounding areas clean and free from birds, pigeons, scavengers, vermin, creatures and other animals.
- (f) If Agency (including its contractors and agents) or BNSF, on behalf of Agency, performs (i) alterations or modifications to the Structure, or (ii) any maintenance or other work on the Structure with heavy tools, equipment or machinery at ground surface level horizontally within 25'-0" of the centerline of the nearest track, or (iii) any maintenance or other work outside the limits of the deck of the Structure vertically above the top of the rail, then Agency or its contractors and/or agents must procure and maintain the following insurance coverage, which may be changed from time to time:

Railroad Protective Liability insurance naming only **BNSF** as the Insured with coverage of at least \$5,000,000 per occurrence and \$10,000,000 in the aggregate. The policy shall be issued on a standard ISO form CG 00 35 12 04 and include the following:

- Endorsed to include the Pollution Exclusion Amendment

- Endorsed to include the Limited Seepage and Pollution Endorsement.
- Endorsed to remove any exclusion for punitive damages.
- Endorsed to include Evacuation Expense Coverage Endorsement.
- No other endorsements restricting coverage may be added.
- The original policy must be provided to **BNSF** prior to performing any work or services under this Agreement
- Definition of "Physical Damage to Property" shall be endorsed to read: "means direct and accidental loss of or damage to all property owned by any named insured and all property in any named insured' care, custody, and control arising out of the acts or omissions of the contractor named on the Declarations.

As used in this paragraph, "**BNSF**" means "Burlington Northern Santa Fe, LLC", "BNSF RAILWAY COMPANY" and the subsidiaries, successors, assigns and affiliates of each.

In lieu of providing a Railroad Protective Liability Policy, Agency may participate in BNSF's Blanket Railroad Protective Liability Insurance Policy if available to Agency or its contractors. The limits of coverage are the same as above.

12. Agency hereby grants to BNSF, at no cost or expense to BNSF, a permanent right of access from Agency property to BNSF tracks for maintenance purposes.

13. Agency must provide one set of as built plans (prepared in **English Units**) to BNSF, as well as one set of computer diskettes containing as built CAD drawings of the Structure and identifying the software used for the CAD drawings. The "as built plans" must comply with the BNSF Requirements for construction of Grade Separation Projects set forth on Exhibit F and depict all information in BNSF engineering stationing and mile post pluses. The "as built plans" must also include plan and profile, structural bridge drawings and specifications, and drainage plans. All improvements and facilities must be shown.

14. Subject to the restrictions imposed by Article IV, Section 9 above and in accordance with the requirements of Article III, Section 9 above, Agency must notify and obtain prior authorization

from BNSF's Manager of Public Projects before entering BNSF's right-of-way for **INSPECTION OR MAINTENANCE** purposes, and the BNSF Manager of Public Projects will determine if flagging is required. If the construction work hereunder is contracted, Agency must require its prime contractor(s) to comply with the obligations set forth in Exhibit C and Exhibit C-1, as the same may be revised from time to time. Agency will be responsible for its contractor(s) compliance with such obligations.

15. In the event that BNSF shall deem it necessary or desirable in the future, in the performance of its duty as a common carrier, to raise or lower the grade or change the alignment of its tracks or to lay additional track or tracks or to build other facilities in connection with the operation of its railroad, BNSF shall, at its expense, have full right to make such changes or additions, provided such changes or additions do not change or alter the Structure herein proposed to be constructed and provided further, however, that should it become necessary or desirable in the future to change, alter, widen or reconstruct the Structure to accommodate railroad projects, the cost of such work, including any cost incidental to alteration of railroad or highway facilities made necessary by the alteration of the Structure shall be the sole responsibility of Agency.

16. Agency may, at Agency's sole expense, alter or reconstruct the highway components of the Structure if necessary or desirable, due to traffic conditions or pedestrian or other recreational traffic, provided, however, that any such alteration or reconstruction must receive BNSF's prior written acceptance as evidenced by either a supplement to this Agreement, or execution of a new agreement that provides for the termination of this Agreement. Furthermore, any alteration or reconstruction of the highway components of the Structure will be covered by a Commission Order.

17. Any books, papers, records and accounts of the parties hereto relating to the work hereunder or the costs or expenses for labor and material connected with the construction will at all reasonable times be open to inspection and audit by the agents and authorized representatives of the parties hereto, as well as the State of California and the Federal Highway Administration, for a period of one (1) year from the date of the final BNSF invoice under this Agreement.

18. The covenants and provisions of this Agreement are binding upon and inure to the benefit of the successors and assigns of the parties hereto. Notwithstanding the preceding sentence, neither party hereto may assign any of its rights or obligations hereunder without the prior written consent of the other party.

19. In the event construction of the Project does not commence within 36 months of the Effective Date, this Agreement will become null and void.

20. Neither termination nor expiration of this Agreement will release either party from any liability or obligation under this Agreement, whether of indemnity or otherwise, resulting from any acts, omissions or events happening prior to the date of termination or expiration.

21. To the maximum extent possible, each provision of this Agreement will be interpreted in such a manner as to be effective and valid under applicable law. If any provision of this Agreement is prohibited by, or held to be invalid under, applicable law, such provision will be ineffective solely to the extent of such prohibition or invalidity and the remainder of the provision will be enforceable.

22. This Agreement (including exhibits and other documents, manuals, etc. incorporated herein) is the full and complete agreement between BNSF and Agency with respect to the subject matter herein and supersedes any and all other prior agreements between the parties hereto.

23. Any notice provided for herein or concerning this Agreement must be in writing and will be deemed sufficiently given when sent by certified mail, return receipt requested, to the parties at the following addresses:

BNSF:

BNSF's Manager of Public Projects

Agency:

City of Corona, Public Works Director
/ City Engineer

Savat Khamphou
400 S. Vicentia Avenue
Corona, CA 92882

IN WITNESS WHEREOF, the parties hereto have caused this Agreement to be executed and attested by its duly qualified and authorized officials as of the day and year first above written.

BNSF RAILWAY COMPANY

DocuSigned by:
By: John Cech
EB0A272010FE44B...

Printed Name: John Cech

Title: Vice President - Engineering

WITNESS:

DocuSigned by:
Cheryl Townlian
3CDF5D6049A34A2...

AGENCY

CITY OF CORONA

DocuSigned by:
By: Savat Khamphou
CB312E179B8E403...

Printed Name: Savat Khamphou

Title: Acting Public Works Director/City Engineer

WITNESS:

DocuSigned by:
Laura Lopez
2244DC5A2280436...

Exhibit A
To Overpass Agreement

Project Description

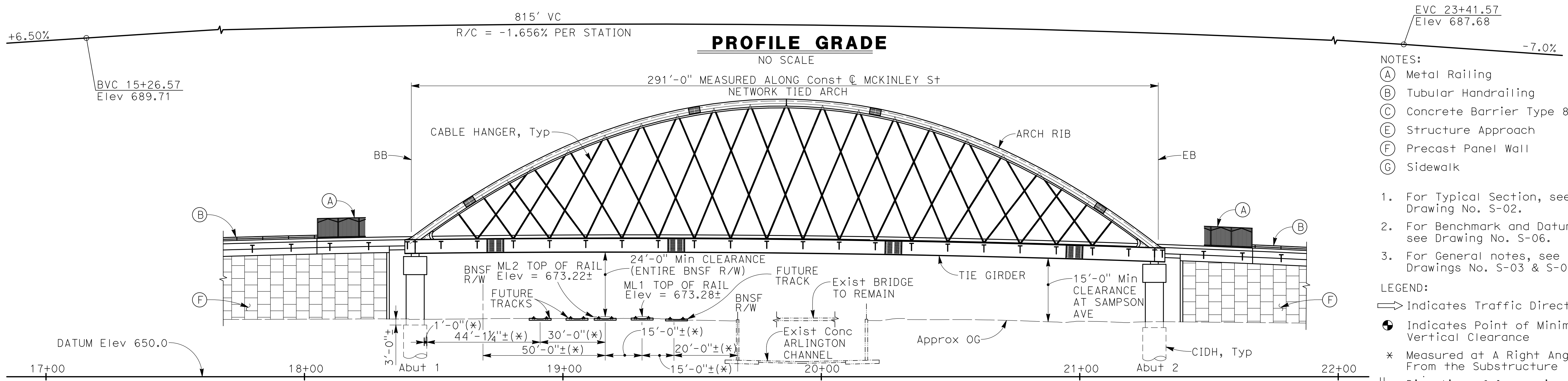

- NOTES:**
- (A) Metal Railing
 - (B) Tubular Handrailing
 - (C) Concrete Barrier Type 836
 - (E) Structure Approach
 - (F) Precast Panel Wall
 - (G) Sidewalk
1. For Typical Section, see Drawing No. S-02.
 2. For Benchmark and Datum, see Drawing No. S-06.
 3. For General notes, see Drawings No. S-03 & S-04.
- LEGEND:**
- Indicates Traffic Direction
 - ⊕ Indicates Point of Minimum Vertical Clearance
 - * Measured at A Right Angle From the Substructure
 - ⊕ Direction of Increasing Milepost
 - CP Control Point

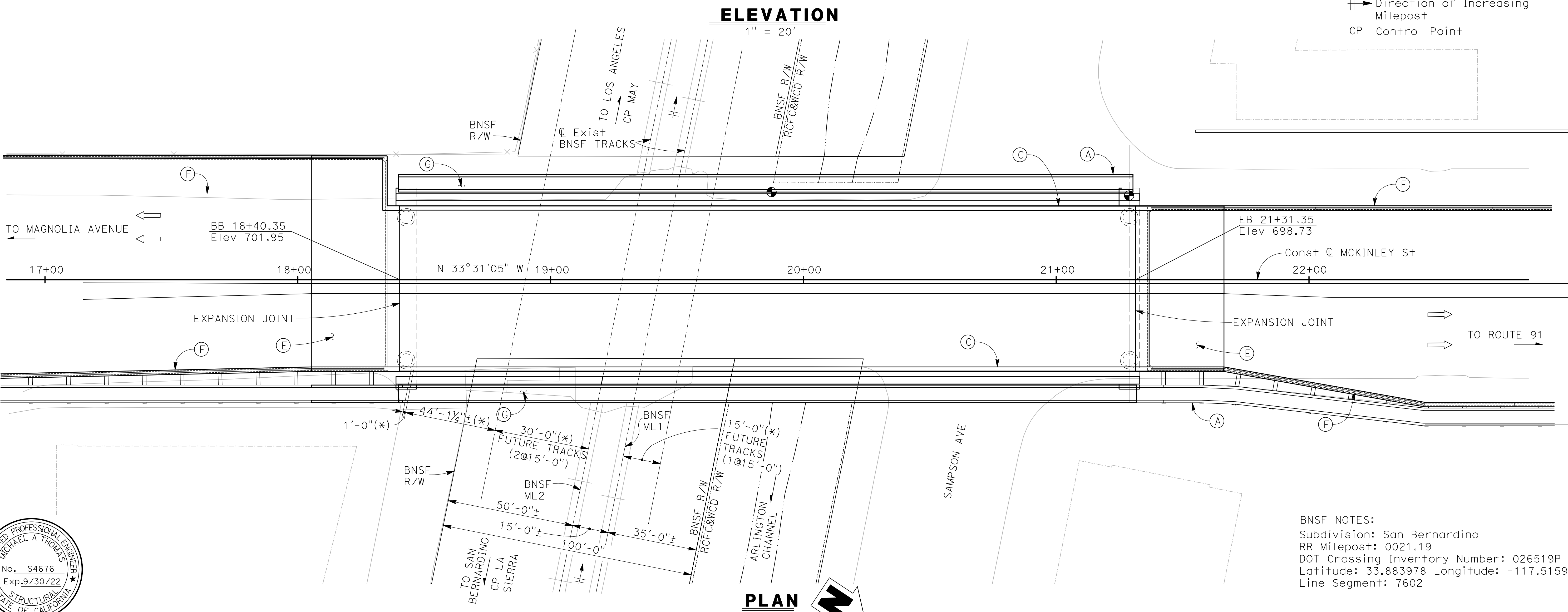

BNSF NOTES:
 Subdivision: San Bernardino
 RR Milepost: 0021.19
 DOT Crossing Inventory Number: 026519P
 Latitude: 33.883978 Longitude: -117.515943
 Line Segment: 7602



BIGGS CARDOSA ASSOCIATES INC
 STRUCTURAL ENGINEERS
 500 So. Main St, Suite 400
 Orange, California 92668
 714-550-4665

Designed by	Drawn by	Checked by	Date	By	REVISIONS	App'd
AJE	SMH	JCC	3/2/2021			

PLANS PREPARED UNDER SUPERVISION OF MICHAEL THOMAS
 Date 3/2/2021 R.C.E. No. 54676

BASIS OF BEARINGS
 THIS PROJECT IS BASED ON THE CALIFORNIA COORDINATE SYSTEM (CCS83), ZONE VI, 1983 NAD, (1991.35 EPOCH), GPS DERIVED.

BENCH MARK
 ELEVATIONS ARE BASED ON THE CITY OF CORONA BENCHMARK #C-113, A 2 1/2" BRASS DISK STAMPED "C-113", SET IN THE TOP OF CURB, LOCATED 5' NORTH OF THE BCR OF THE NORTHWESTERLY CURB OF THE INTERSECTION OF SAMPSON AVE AND MCKINLEY ST. ELEVATION = 670.387 FEET (NGVD29)

Approved By: *Savat Khamphou* 3/2/2021
 Date
Savat Khamphou
 Acting Public Works Director / City Engineer
 R.C.E. No. 62019

CITY OF CORONA MCKINLEY STREET GRADE SEPARATION
 GENERAL PLAN No. 1

Dwg ID 19-042S
 S-01
 Sh of

BNSF SUBMITTAL - NOT FOR CONSTRUCTION (03/2/2021)

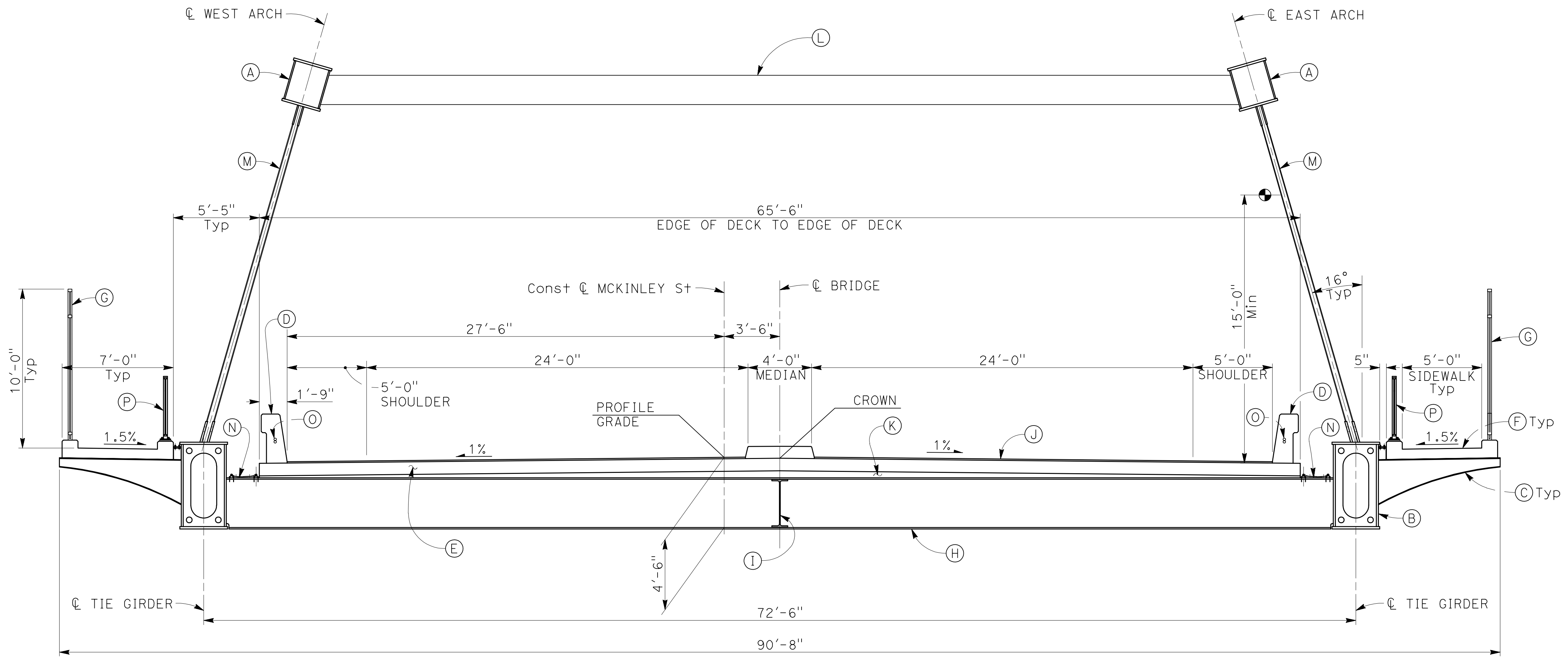

- LEGEND:**
- (A) Arch rib
 - (B) Tie girder
 - (C) Sidewalk overhang bracket
 - (D) Concrete barrier type 836
 - (E) CIP concrete deck
 - (F) CIP concrete sidewalk
 - (G) Metal railing
 - (H) Transverse floorbeam
 - (I) Longitudinal diaphragm
 - (J) 1" Polyster concrete overlay
 - (K) CIP concrete haunch
 - (L) Arch rib bracing
 - (M) Cable hanger
 - (N) Steel mesh protection
 - (O) 2-2" Dia electric conduits
 - (P) Picket railing
 - Point of min vert clearance

TYPICAL SECTION
 $\frac{1}{4}'' = 1'-0''$

NOTE:
 THE BRIDGE IS SYMMETRICAL
 ABOUT THE \bar{C} BRIDGE.

- NOTES:
1. Transverse floorbeams shall be oriented normal to the profile grade line.
 2. For cable hanger details, see Drawing No. S-32.
 3. For tie girder details, see Drawing No. S-24.
 4. For arch rib details, see Drawing No. S-16.
 5. For arch rib lateral bracing details, see Drawing No. S-23.
 6. For floorbeam details, see Drawing No. S-40.
 7. For longitudinal diaphragm details, see Drawing No. S-48.
 8. For sidewalk overhang bracket details, see Drawing No. S-47.
 9. For deck slab details, see Drawing No. S-50.
 10. For metal railing details, see Drawing No. S-65.
 11. For steel mesh protection details, see Drawing No. S-68 & S-69.
 12. For picket railing details, see Drawing No. S-67.

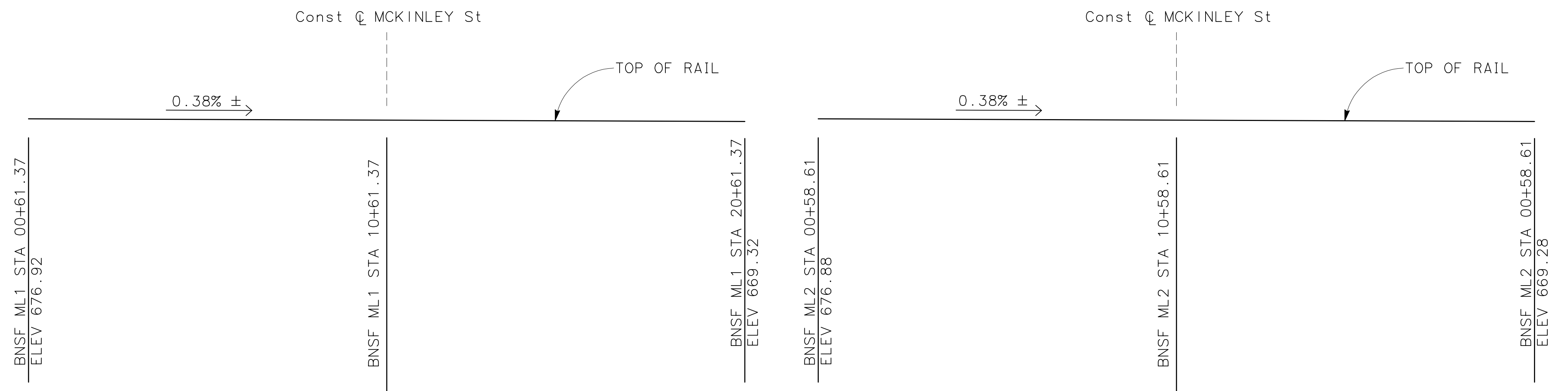

RAILROAD PROFILE GRADE DIAGRAM
 NO SCALE

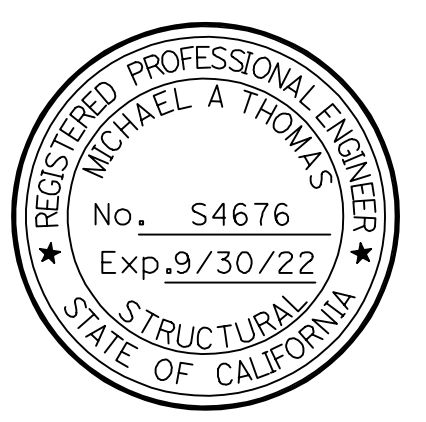

BIGGS CARDOSA ASSOCIATES INC
BCA
 500 So. Main St, Suite 400
 Orange, California 92668
 714-550-4665

Designed by AJE	Drawn by SMH	Checked by JCC	Date	By	REVISIONS	App'd
PLANS PREPARED UNDER SUPERVISION OF MICHAEL THOMAS			Date 3/2/2021	R.C.E. No. S4676		

BASIS OF BEARINGS
 THIS PROJECT IS BASED ON THE CALIFORNIA COORDINATE SYSTEM (CCS83), ZONE VI, 1983 NAD, (1991.35 EPOCH), GPS DERIVED.

BENCH MARK
 ELEVATIONS ARE BASED ON THE CITY OF CORONA BENCHMARK #C-113, A 2 1/2" BRASS DISK STAMPED "C-113", SET IN THE TOP OF CURB, LOCATED 5' NORTH OF THE BCR OF THE NORTH-WESTERLY CURB OF THE INTERSECTION OF SAMPSON AVE AND MCKINLEY ST. ELEVATION = 670.387 FEET (NGVD29)

Approved By: *Savat Khamphou* 3/2/2021
Savat Khamphou
 Acting Public Works Director / City Engineer
 R.C.E. No. 62019

CITY OF CORONA MCKINLEY STREET GRADE SEPARATION
 GENERAL PLAN No. 2

Dwg ID 19-042S
 S-02
 Sh of

2018243

**EASEMENT AGREEMENT
FOR MCKINLEY STREET OVERPASS
(C&M Agreement)**

THIS EASEMENT AGREEMENT FOR CONSTRUCTING A NEW SEPARATED GRADE CROSSING AT McKinley Street ("**Easement Agreement**") is made and entered into as of the _____ day of _____ 2021 ("**Effective Date**"), by and between **BNSF RAILWAY COMPANY**, a Delaware corporation ("**Grantor**"), and the **CITY OF CORONA**, a political subdivision of the State of California ("**Grantee**").

A. Grantor owns or controls certain real property situated at or near the vicinity of Corona, County of Riverside, State of California, at Railroad Line Segment 7602-1, Mile Post 21.14, as described or depicted on **Exhibit "A"** attached hereto and made a part hereof (the "**Premises**").

B. Grantor and Grantee have entered into that certain Construction and Maintenance Agreement dated as of _____ concerning improvements on or near the Premises (the "**C&M Agreement**").

C. Grantee has requested that Grantor grant to Grantee an easement over the Premises for the Easement Purpose (as defined below).

D. Grantor has agreed to grant Grantee such easement, subject to the terms and conditions set forth in this Easement and in the C&M Agreement incorporated herein as if fully set forth in this instrument which terms shall be in full force and effect for purposes of this Easement even if the C&M Agreement is, for whatever reason, no longer in effect.

NOW, THEREFORE, for and in consideration of the foregoing recitals which are incorporated herein, the mutual promises contained herein, and other good and valuable consideration, the receipt and sufficiency of which are hereby acknowledged, the parties agree as follows:

Section 1 Granting of Easement.

1.1 Easement Purpose. The "**Easement Purpose**" shall be for the purposes set forth in the C&M Agreement. Any improvements to be constructed in connection with the Easement Purpose are referred to herein as "**Improvements**" and shall be constructed, located, configured and maintained by Grantee in strict accordance with the terms of this Easement Agreement and the C&M Agreement.

1.2 Grant. Grantor does hereby grant unto Grantee a non-exclusive easement ("**Easement**") over the Premises for the Easement Purpose and for no other purpose. The Easement is granted subject to any and all restrictions, covenants, easements, licenses, permits, leases and other encumbrances of whatsoever nature whether or not of record, if any, relating to the Premises and subject to all with all applicable federal, state and local laws, regulations, ordinances, restrictions, covenants and court or administrative decisions and orders, including Environmental Laws (defined below) and zoning laws (collectively, "**Laws**"). Grantor may not make any alterations or improvements or perform any maintenance or repair activities within the Premises except in accordance with the terms and conditions of the C&M Agreement.

1.3 Reservations by Grantor. Grantor excepts and reserves the right, to be exercised by Grantor and any other parties who may obtain written permission or authority from Grantor:

- (a) to install, construct, maintain, renew, repair, replace, use, operate, change, modify and relocate any existing pipe, power, communication, cable, or utility lines and appurtenances and other facilities or structures of like character (collectively, "**Lines**") upon, over, under or across the Premises;
- (b) to install, construct, maintain, renew, repair, replace, use, operate, change, modify and relocate any tracks or additional facilities or structures upon, over, under or across the Premises; and

- (c) to use the Premises in any manner as the Grantor in its sole discretion deems appropriate, provided Grantor uses all commercially reasonable efforts to avoid material interference with the use of the Premises by Grantee for the Easement Purpose.

Section 2 **Term of Easement.** The term of the Permanent Easement, unless sooner terminated under provisions of this Easement Agreement, shall be perpetual.

Section 3 **No Warranty of Any Conditions of the Premises.** Grantee acknowledges that Grantor has made no representation whatsoever to Grantee concerning the state or condition of the Premises, or any personal property located thereon, or the nature or extent of Grantor's ownership interest in the Premises. Grantee has not relied on any statement or declaration of Grantor, oral or in writing, as an inducement to entering into this Easement Agreement, other than as set forth herein. GRANTOR HEREBY DISCLAIMS ANY REPRESENTATION OR WARRANTY, WHETHER EXPRESS OR IMPLIED, AS TO THE DESIGN OR CONDITION OF ANY PROPERTY PRESENT ON OR CONSTITUTING THE PREMISES, ITS MERCHANTABILITY OR FITNESS FOR ANY PARTICULAR PURPOSE, THE QUALITY OF THE MATERIAL OR WORKMANSHIP OF ANY SUCH PROPERTY, OR THE CONFORMITY OF ANY SUCH PROPERTY TO ITS INTENDED USES. GRANTOR SHALL NOT BE RESPONSIBLE TO GRANTEE OR ANY OF GRANTEE'S CONTRACTORS FOR ANY DAMAGES RELATING TO THE DESIGN, CONDITION, QUALITY, SAFETY, MERCHANTABILITY OR FITNESS FOR ANY PARTICULAR PURPOSE OF ANY PROPERTY PRESENT ON OR CONSTITUTING THE PREMISES, OR THE CONFORMITY OF ANY SUCH PROPERTY TO ITS INTENDED USES. GRANTEE ACCEPTS ALL RIGHTS GRANTED UNDER THIS EASEMENT AGREEMENT IN THE PREMISES IN AN "AS IS, WHERE IS" AND "WITH ALL FAULTS" CONDITION, AND SUBJECT TO ALL LIMITATIONS ON GRANTOR'S RIGHTS, INTERESTS AND TITLE TO THE PREMISES. Grantee has inspected or will inspect the Premises, and enters upon Grantor's rail corridor and property with knowledge of its physical condition and the danger inherent in Grantor's rail operations on or near the Premises. Grantee acknowledges that this Easement Agreement does not contain any implied warranties that Grantee or Grantee's Contractors (as hereinafter defined) can successfully construct or operate the Improvements.

Section 4 **Nature of Grantor's Interest in the Premises.** GRANTOR DOES NOT WARRANT ITS TITLE TO THE PREMISES NOR UNDERTAKE TO DEFEND GRANTEE IN THE PEACEABLE POSSESSION OR USE THEREOF. NO COVENANT OF QUIET ENJOYMENT IS MADE. In case of the eviction of Grantee by anyone owning or claiming title to or any interest in the Premises, or by the abandonment by Grantor of the affected rail corridor, Grantor shall not be liable to refund Grantee any compensation paid hereunder.

Section 5 **Improvements.** Grantee shall take, in a timely manner, all actions necessary and proper to the lawful establishment, construction, operation, and maintenance of the Improvements, including such actions as may be necessary to obtain any required permits, approvals or authorizations from applicable governmental authorities. Any and all cuts and fills, excavations or embankments necessary in the construction, maintenance, or future alteration of the Improvements shall be made and maintained in such manner, form and extent as will provide adequate drainage of and from the adjoining lands and premises of the Grantor; and wherever any such fill or embankment shall or may obstruct the natural and pre-existing drainage from such lands and premises of the Grantor, the Grantee shall construct and maintain such culverts or drains as may be requisite to preserve such natural and pre-existing drainage, and shall also wherever necessary, construct extensions of existing drains, culverts or ditches through or along the premises of the Grantor, such extensions to be of adequate sectional dimensions to preserve the present flowage of drainage or other waters, and of materials and workmanship equally as good as those now existing. In the event any construction, repair, maintenance, work or other use of the Premises by Grantee will affect any Lines, fences, buildings, improvements or other facilities (collectively, "**Other Improvements**"), Grantee will be responsible at Grantee's sole risk to locate and make any adjustments necessary to such Other Improvements. Grantee must contact the owner(s) of the Other Improvements notifying them of any work that may damage these Other Improvements and/or interfere with their service and obtain the owner's written approval prior to so affecting the Other Improvements. Grantee must mark all Other Improvements on the Plans and Specifications and mark such Other Improvements in the field in order to verify their locations. Grantee must also use all reasonable methods when working on or near Grantor property to determine if any Other Improvements (fiber optic, cable, communication or otherwise) may exist. The Grantee agrees to keep the above-described premises free and clear from combustible materials and to cut and remove or cause to be cut and removed at its sole expense all weeds and vegetation on said premises, said

work of cutting and removal to be done at such times and with such frequency as to comply with Grantee and local laws and regulations and abate any and all hazard of fire.

Section 6 Taxes and Recording Fees. Grantee shall pay when due any taxes, assessments or other charges (collectively, "**Taxes**") levied or assessed upon the Improvements by any governmental or quasi-governmental body or any Taxes levied or assessed against Grantor or the Premises that are attributable to the Improvements. Grantee agrees to purchase, affix and cancel any and all documentary stamps in the amount prescribed by statute, and to pay any and all required transfer taxes, excise taxes and any and all fees incidental to recordation of the Memorandum of Easement. In the event of Grantee's failure to do so, if Grantor shall become obligated to do so, Grantee shall be liable for all costs, expenses and judgments to or against Grantor, including all of Grantor's legal fees and expenses.

Section 7 Environmental.

7.1 Compliance with Environmental Laws. Grantee shall strictly comply with all federal, state and local environmental Laws in its use of the Premises, including, but not limited to, the Resource Conservation and Recovery Act, as amended (RCRA), the Clean Water Act, the Oil Pollution Act, the Hazardous Materials Transportation Act, the Comprehensive Environmental Response, Compensation and Liability Act (CERCLA) and the Toxic Substances Control Act (collectively referred to as the "**Environmental Laws**"). Grantee shall not maintain a "treatment," "storage," "transfer" or "disposal" facility, or "underground storage tank," as those terms are defined by Environmental Laws, on the Premises. Grantee shall not handle, transport, release or suffer the release of "hazardous waste" or "hazardous substances", as "hazardous waste" and "hazardous substances" may now or in the future be defined by any Environmental Laws.

7.2 Notice of Release. Grantee shall give Grantor immediate notice to Grantor's Resource Operations Center at (800) 832-5452 of any release of hazardous substances on or from the Premises, violation of Environmental Laws, or inspection or inquiry by governmental authorities charged with enforcing Environmental Laws with respect to Grantee's use of the Premises. Grantee shall use its best efforts to promptly respond to any release on or from the Premises. Grantee also shall give Grantor immediate notice of all measures undertaken on behalf of Grantee to investigate, remediate, respond to or otherwise cure such release or violation.

7.3 Remediation of Release. In the event that Grantor has notice from Grantee or otherwise of a release or violation of Environmental Laws which occurred or may occur during the term of this Easement Agreement, Grantor may require Grantee, at Grantee's sole risk and expense, to take timely measures to investigate, remediate, respond to or otherwise cure such release or violation affecting the Premises. If during the construction or subsequent maintenance of the Improvements, soils or other materials considered to be environmentally contaminated are exposed, Grantee will remove and safely dispose of said contaminated soils. Determination of soils contamination and applicable disposal procedures thereof, will be made only by an agency having the capacity and authority to make such a determination.

7.4 Preventative Measures. Grantee shall promptly report to Grantor in writing any conditions or activities upon the Premises known to Grantee which create a risk of harm to persons, property or the environment and shall take whatever action is necessary to prevent injury to persons or property arising out of such conditions or activities; provided, however, that Grantee's reporting to Grantor shall not relieve Grantee of any obligation whatsoever imposed on it by this Easement Agreement. Grantee shall promptly respond to Grantor's request for information regarding said conditions or activities.

7.5 Evidence of Compliance. Grantee agrees periodically to furnish Grantor with proof satisfactory to Grantor that Grantee is in compliance with this **Section 7**. Should Grantee not comply fully with the above-stated obligations of this **Section 7**, notwithstanding anything contained in any other provision hereof, Grantor may, at its option, terminate this Easement Agreement by serving five (5) days' notice of termination upon Grantee. Upon termination, Grantee shall remove the Improvements and restore the Premises as provided in **Section 9**.

Section 8 **Default and Termination.**

8.1 **Grantor's Performance Rights.** If at any time Grantee, or Grantee's Contractors, fails to properly perform its obligations under this Easement Agreement, Grantor, in its sole discretion, may: (i) seek specific performance of the unperformed obligations, or (ii) at Grantee's sole cost, may arrange for the performance of such work as Grantor deems necessary for the safety of its rail operations, activities and property, or to avoid or remove any interference with the activities or property of Grantor, or anyone or anything present on the rail corridor or property with the authority or permission of Grantor. Grantee shall promptly reimburse Grantor for all costs of work performed on Grantee's behalf upon receipt of an invoice for such costs. Grantor's failure to perform any obligations of Grantee or Grantee's Contractors shall not alter the liability allocation set forth in this Easement Agreement.

8.2 **Abandonment.** Grantor may, at its option, terminate this Easement Agreement by serving five (5) days' notice in writing upon Grantee if Grantee should abandon or cease to use the Premises for the Easement Purpose. Any waiver by Grantor of any default or defaults shall not constitute a waiver of the right to terminate this Easement Agreement for any subsequent default or defaults, nor shall any such waiver in any way affect Grantor's ability to enforce any section of this Easement Agreement.

8.3 **Effect of Termination or Expiration.** Neither termination nor expiration will release Grantee from any liability or obligation under this Easement, whether of indemnity or otherwise, resulting from any acts, omissions or events happening prior to the date of termination or expiration, or, if later, the date the Premises are restored as required by **Section 9**.

8.4 **Non-exclusive Remedies.** The remedies set forth in this **Section 8** shall be in addition to, and not in limitation of, any other remedies that Grantor may have under the C&M Agreement, at law or in equity.

Section 9 **Surrender of Premises.**

9.1 **Removal of Improvements and Restoration.** Upon termination of this Easement Agreement, whether by abandonment of the Easement or by the exercise of Grantor's termination rights hereunder, Grantee shall, at its sole cost and expense, immediately perform the following:

- (a) remove all or such portion of Grantee's Improvements and all appurtenances thereto from the Premises, as Grantor directs at Grantor's sole discretion;
- (b) repair and restore any damage to the Premises arising from, growing out of, or connected with Grantee's use of the Premises;
- (c) remedy any unsafe conditions on the Premises created or aggravated by Grantee; and
- (d) leave the Premises in the condition which existed as of the Effective Date.

9.2 **Limited License for Entry.** If this Easement Agreement is terminated, Grantor may direct Grantee to undertake one or more of the actions set forth above, at Grantee's sole cost, in which case Grantee shall have a limited license to enter upon the Premises to the extent necessary to undertake the actions directed by Grantor. The terms of this limited license include all of Grantee's obligations under this Easement Agreement. Termination will not release Grantee from any liability or obligation under this Easement Agreement, whether of indemnity or otherwise, resulting from any acts, omissions or events happening prior to the date of termination, or, if later, the date when Grantee's Improvements are removed and the Premises are restored to the condition that existed as of the Effective Date. If Grantee fails to surrender the Premises to Grantor upon any termination of the Easement, all liabilities and obligations of Grantee hereunder shall continue in effect until the Premises are surrendered.

Section 10 **Liens.** Grantee shall promptly pay and discharge any and all liens arising out of any construction, alterations or repairs done, suffered or permitted to be done by Grantee on the Premises or attributable to Taxes that are the responsibility of Grantee pursuant to **Section 6**. Grantor is hereby authorized

to post any notices or take any other action upon or with respect to the Premises that is or may be permitted by Law to prevent the attachment of any such liens to any portion of the Premises; provided, however, that failure of Grantor to take any such action shall not relieve Grantee of any obligation or liability under this **Section 10** or any other section of this Easement Agreement.

Section 11 **Tax Exchange.** Grantor may assign its rights (but not its obligations) under this Easement Agreement to Goldfinch Exchange Company LLC, an exchange intermediary, in order for Grantor to effect an exchange under Section 1031 of the Internal Revenue Code. In such event, Grantor shall provide Grantee with a Notice of Assignment, attached as Exhibit C, and Grantee shall execute an acknowledgement of receipt of such notice.

Section 12 **Notices.** Any notice required or permitted to be given hereunder by one party to the other shall be delivered in the manner set forth in the C&M Agreement. Notices to Grantor under this Easement shall be delivered to the following address: BNSF Railway Company, Real Estate Department, 2501 Lou Menk Drive, Ft. Worth, TX 76131, Attn: Real Estate, or such other address as Grantor may from time to time direct by notice to Grantee.

Section 13 **Recordation.** It is understood and agreed that this Easement Agreement shall not be in recordable form and shall not be placed on public record and any such recording shall be a breach of this Easement Agreement. Grantor and Grantee shall execute a Memorandum of Easement in the form attached hereto as Exhibit "B" (the "**Memorandum of Easement**") subject to changes required, if any, to conform such form to local recording requirements. The Memorandum of Easement shall be recorded in the real estate records in the county where the Premises are located. If a Memorandum of Easement is not executed by the parties and recorded as described above within 30 days of the Effective Date, Grantor shall have the right to terminate this Easement Agreement upon notice to Grantee.

Section 14 **Miscellaneous.**

14.1 All questions concerning the interpretation or application of provisions of this Easement Agreement shall be decided according to the substantive Laws of the State of California without regard to conflicts of law provisions.

14.2 In the event that Grantee consists of two or more parties, all the covenants and agreements of Grantee herein contained shall be the joint and several covenants and agreements of such parties. This instrument and all of the terms, covenants and provisions hereof shall inure to the benefit of and be binding upon each of the parties hereto and their respective legal representatives, successors and assigns and shall run with and be binding upon the Premises.

14.3 If any action at law or in equity is necessary to enforce or interpret the terms of this Easement Agreement, the prevailing party or parties shall be entitled to reasonable attorneys' fees, costs and necessary disbursements in addition to any other relief to which such party or parties may be entitled.

14.4 If any provision of this Easement Agreement is held to be illegal, invalid or unenforceable under present or future Laws, such provision will be fully severable and this Easement Agreement will be construed and enforced as if such illegal, invalid or unenforceable provision is not a part hereof, and the remaining provisions hereof will remain in full force and effect. In lieu of any illegal, invalid or unenforceable provision herein, there will be added automatically as a part of this Easement Agreement a provision as similar in its terms to such illegal, invalid or unenforceable provision as may be possible and be legal, valid and enforceable.

14.5 This Easement Agreement is the full and complete agreement between Grantor and Grantee with respect to all matters relating to Grantee's use of the Premises and supersedes any and all other agreements between the parties hereto relating to Grantee's use of the Premises as described herein. However, nothing herein is intended to terminate any surviving obligation of Grantee or Grantee's obligation to defend and hold Grantor harmless in any prior written agreement between the parties.

14.6 Time is of the essence for the performance of this Easement Agreement.

ADMINISTRATIVE FEE

15. Grantee acknowledges that a material consideration for this agreement, without which it would not be made, is the agreement between Grantee and Grantor, that the Grantee shall pay upon return of this Agreement signed by Grantee to Grantor's Broker a processing fee in the amount of **\$2,500.00** over and above the agreed upon Acquisition Price. Said fee shall be made payable to BNSF Railway Company by a separate check.

Witness the execution of this Easement Agreement as of the date first set forth above.

GRANTOR:

BNSF RAILWAY COMPANY, a Delaware corporation

By: _____
Name: _____
Title: _____

GRANTEE:

The **CITY OF CORONA**,
a political subdivision of the State of California

By: _____
Name: _____
Title: _____

EXHIBIT "B"

MEMORANDUM OF EASEMENT

MEMORANDUM OF EASEMENT

THIS MEMORANDUM OF EASEMENT is hereby executed this _____ day of _____, 2021, by and between **BNSF RAILWAY COMPANY**, a Delaware corporation ("**Grantor**"), whose address for purposes of this instrument is 2500 Lou Menk Drive, Fort Worth, Texas 76131, and the CITY OF CORONA, a political subdivision of the State of California ("**Grantee**"), whose address for purposes of this instrument is _____, which terms "Grantor" and "Grantee" shall include, wherever the context permits or requires, singular or plural, and the heirs, legal representatives, successors and assigns of the respective parties:

WITNESSETH:

WHEREAS, Grantor owns or controls certain real property situated in Riverside County, California, as described on **Exhibit "A"** attached hereto and incorporated herein by reference (the "**Premises**");

WHEREAS, Grantor and Grantee entered into an Easement Agreement, dated _____, 2021 (the "**Easement Agreement**") which set forth, among other things, the terms of an easement granted by Grantor to Grantee over and across the Premises (the "**Easement**"); and

WHEREAS, Grantor and Grantee desire to memorialize the terms and conditions of the Easement Agreement of record.

For valuable consideration the receipt and sufficiency of which are hereby acknowledged, Grantor does grant unto Grantee and Grantee does hereby accept from Grantor the Easement over and across the Premises.

The term of the Easement, unless sooner terminated under provisions of the Easement Agreement, shall be perpetual.

All the terms, conditions, provisions and covenants of the Easement Agreement are incorporated herein by this reference for all purposes as though written out at length herein, and both the Easement Agreement and this Memorandum of Easement shall be deemed to constitute a single instrument or document. This Memorandum of Easement is not intended to amend, modify, supplement, or supersede any of the provisions of the Easement Agreement and, to the extent there may be any conflict or inconsistency between the Easement Agreement or this Memorandum of Easement, the Easement Agreement shall control.

IN WITNESS WHEREOF, Grantor and Grantee have executed this Memorandum of Easement to as of the date and year first above written.

GRANTOR:

BNSF RAILWAY COMPANY, a Delaware corporation

By: _____
Name: _____
Title: _____

STATE OF TEXAS §
 §
COUNTY OF TARRANT §

This instrument was acknowledged before me on the _____ day of _____, 20____, by _____ (name) as _____ (title) of **BNSF RAILWAY COMPANY**, a Delaware corporation.

Notary Public

My appointment expires: _____

(Seal)

GRANTEE:
The **CITY OF CORONA**,
a political subdivision of the State of California

By: _____
Name: _____
Title: _____

STATE OF _____ §
 §
COUNTY OF _____ §

This instrument was acknowledged before me on the _____ day of _____,
20__, by _____ (name) as
_____ (title) of _____, a
_____.

Notary Public

My appointment expires: _____

(Seal)

EXHIBIT "A"

Premises

SCALE: 1 IN = 50 FT

JLL TI #: -
 BW Proj. No.: 12196.003
 MAP REFERENCE:
 STA. =
 R/W =

This map used by BNSF RAILWAY COMPANY in the ordinary course of business, but it is subject to audit and should be used only with the expressed understanding the BNSF make no representations whatsoever about the quality, accuracy, errors or omissions relating to this map.

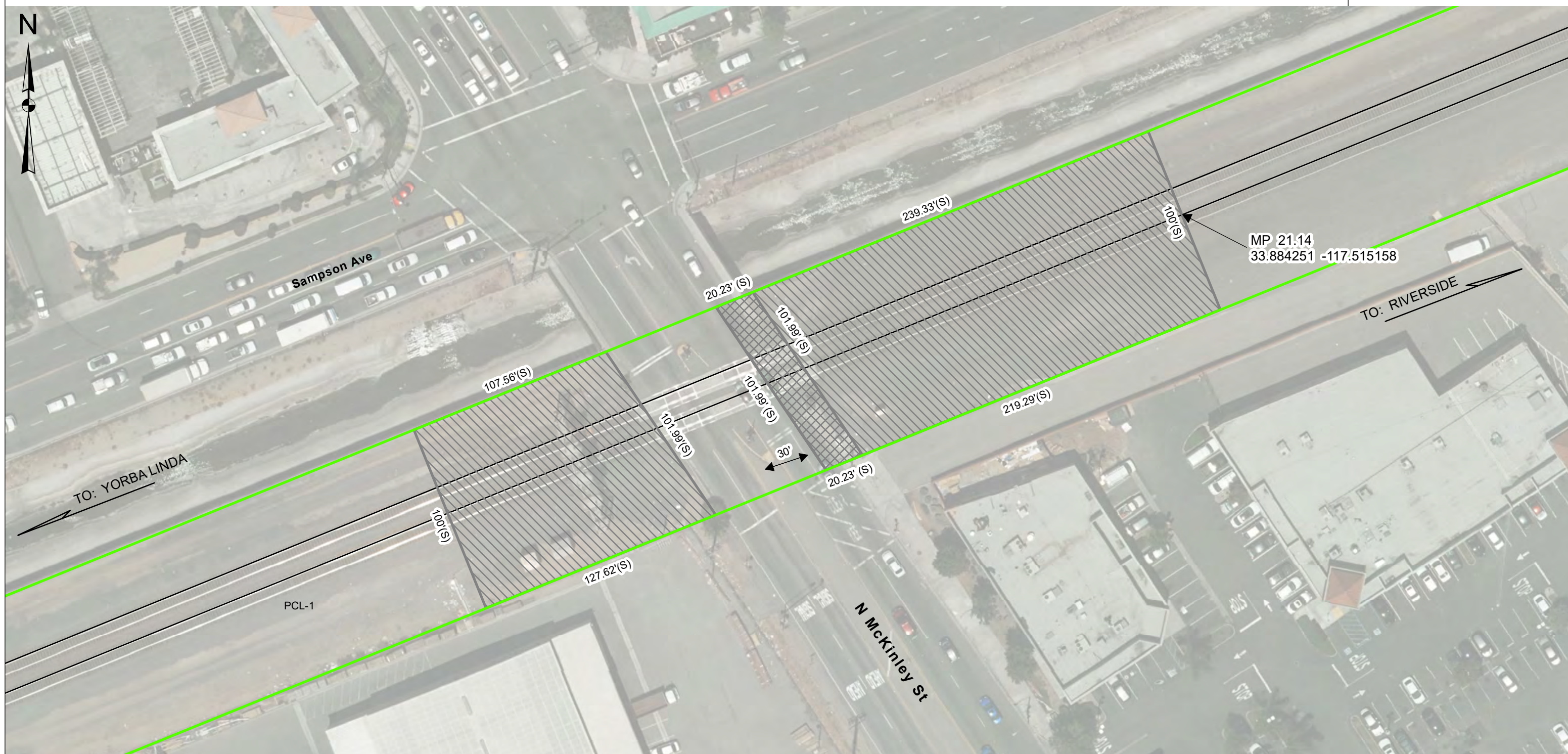

TO: MCKINLEY GS
 AT: CORONA
 RIVERSIDE COUNTY,
 CA

- LEGEND:**
- PERMANENT EASEMENT
 - TEMPORARY EASEMENT
 - RIGHT OF WAY LINE
 - PARCEL LINES
 - TRACK

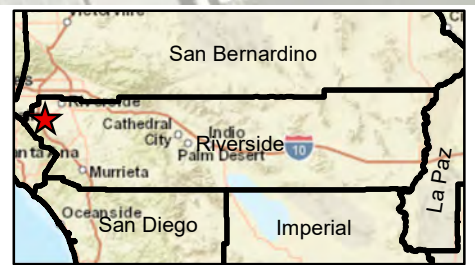

MEASUREMENTS BASED ON PROVIDED SURVEYS
 (S) MEASUREMENTS TAKEN OFF SURVEY
 (M) MEASUREMENT

CALIFORNIA DIVISION
 SAN BERNARDINO SUBDIVISION - L.S. 7602-1
 VAL. SEC. 48060
 AT&SF RY CA-11, MAP CA-11
 SEC. -, T-, R- SBM
 DATE: 6/14/2021
 MP 21.14

EXHIBIT "B-1"
To Overpass Agreement
Memorandum of Easement

THIS MEMORANDUM OF EASEMENT is hereby executed this ____ day of _____, 20____, by and between BNSF RAILWAY COMPANY, a Delaware corporation ("**Grantor**"), whose address for purposes of this instrument is 2500 Lou Menk Drive, Fort Worth, Texas 76131, and _____, a _____ ("**Grantee**"), whose address for purposes of this instrument is _____, which terms "Grantor" and "Grantee" shall include, wherever the context permits or requires, singular or plural, and the heirs, legal representatives, successors and assigns of the respective parties:

WITNESSETH:

WHEREAS, Grantor owns or controls certain real property situated in _____ County, _____ as described on **Exhibit "A-1"** attached hereto and incorporated herein by reference (the "**Premises**");

WHEREAS, Grantor and Grantee entered into an Easement Agreement, dated _____ (the "**Easement Agreement**") which set forth, among other things, the terms of an easement granted by Grantor to Grantee over and across the Premises (the "**Easement**"); and

WHEREAS, Grantor and Grantee desire to memorialize the terms and conditions of the Easement Agreement of record.

For valuable consideration the receipt and sufficiency of which are hereby acknowledged, Grantor does grant unto Grantee and Grantee does hereby accept from Grantor the Easement over and across the Premises.

The term of the Easement, unless sooner terminated under provisions of the Easement Agreement, shall be perpetual. Provisions regulating the use and purposes to which the Easement shall be limited, are set forth in detail in the Easement Agreement and Grantor and Grantee agree to abide by the terms of the Easement Agreement.

All the terms, conditions, provisions and covenants of the Easement Agreement are incorporated herein by this reference for all purposes as though written out at length herein, and both the Easement Agreement and this Memorandum of Easement shall be deemed to constitute a single instrument or document. This Memorandum of Easement is not intended to amend, modify, supplement, or supersede any of the provisions of the Easement Agreement and, to the extent there may be any conflict or inconsistency between the Easement Agreement or this Memorandum of Easement, the Easement Agreement shall control.

[Signature page follows]

IN WITNESS WHEREOF, Grantor and Grantee have executed this Memorandum of Easement to as of the date and year first above written.

GRANTOR:

BNSF RAILWAY COMPANY, a Delaware corporation

By: _____

Name: _____

Title: _____

GRANTEE:

_____,

By: _____

Name: _____

Title: _____

STATE OF _____

§

§

COUNTY OF _____

§

This instrument was acknowledged before me on the ___ day of _____, 20___, by _____ (name) as _____ (title) of BNSF RAILWAY COMPANY, a Delaware corporation.

Notary Public

(Seal)

My appointment expires: _____

STATE OF _____

§

§

COUNTY OF _____

§

This instrument was acknowledged before me on the ___ day of _____, 20___, by
_____(name) as _____(title) of
_____, a _____.

Notary Public

(Seal)

My appointment expires: _____

EXHIBIT "C"

To Overpass Agreement

CONTRACTOR REQUIREMENTS

1.01 General:

- **1.01.01** The Contractor must cooperate with **BNSF RAILWAY COMPANY**, hereinafter referred to as "**Railway**" where work is over or under on or adjacent to Railway property and/or right-of-way, hereafter referred to as "Railway Property", during the construction of the McKinley Street Grade Separation Project.
- **1.01.02** The Contractor must execute and deliver to the Railway duplicate copies of the Exhibit "C-1" Agreement, in the form attached hereto, obligating the Contractor to provide and maintain in full force and effect the insurance called for under Section 3 of said Exhibit "C-1". Questions regarding procurement of the Railroad Protective Liability Insurance should be directed to **Rosa Martinez** at Marsh, USA, 214-303-8519.
- **1.01.03** The Contractor must plan, schedule and conduct all work activities so as not to interfere with the movement of any trains on Railway Property.
- **1.01.04** The Contractor's right to enter Railway's Property is subject to the absolute right of Railway to cause the Contractor's work on Railway's Property to cease if, in the opinion of Railway, Contractor's activities create a hazard to Railway's Property, employees, and/or operations. Railway will have the right to stop construction work on the Project if any of the following events take place: (i) Contractor (or any of its subcontractors) performs the Project work in a manner contrary to the plans and specifications approved by Railway; (ii) Contractor (or any of its subcontractors), in Railway's opinion, prosecutes the Project work in a manner which is hazardous to Railway property, facilities or the safe and expeditious movement of railroad traffic; (iii) the insurance described in the attached Exhibit C-1 is canceled during the course of the Project; or (iv) Contractor fails to pay Railway for the Temporary Construction License or the Easement. The work stoppage will continue until all necessary actions are taken by Contractor or its subcontractor to rectify the situation to the satisfaction of Railway's Division Engineer or until additional insurance has been delivered to and accepted by Railway. In the event of a breach of (i) this Agreement, (ii) the Temporary Construction License, or (iii) the Easement, Railway may immediately terminate the Temporary Construction License or the Easement. Any such work stoppage under this provision will not give rise to any liability on the part of Railway. Railway's right to stop the work is in addition to any other rights Railway may have including, but not limited to, actions or suits for damages or lost profits. In the event that Railway desires to stop construction work on the Project, Railway agrees to immediately notify the following individual in writing:

Savat Khamphou
Public Works Director / City Engineer
400 S. Vicentia Avenue
Corona, CA 92882
951-279-3604
Savat.Khamphou@CoronaCA.gov

- **1.01.05** The Contractor is responsible for determining and complying with all Federal, State and Local Governmental laws and regulations, including, but not limited to environmental laws and regulations (including but not limited to the Resource Conservation and Recovery Act, as amended; the Clean Water Act, the Oil Pollution Act, the Hazardous Materials Transportation Act, CERCLA), and health and safety laws and regulations. The Contractor hereby indemnifies, defends and holds harmless Railway for, from and against all fines or penalties imposed or assessed by Federal, State and Local Governmental Agencies against the Railway which arise out of Contractor's work under this Agreement.
- **1.01.06** The Contractor must notify the City of Corona at (751) 736-2266 and Railway's Manager Public Projects, telephone number (909) 386-4474 at least thirty (30) calendar days before commencing any work on Railway Property. Contractor's notification to Railway must refer to Railway's file _____.
- **1.01.07** For any bridge demolition and/or falsework above any tracks or any excavations located with any part of the excavations located within, whichever is greater, twenty-five (25) feet of the nearest track or intersecting a slope from the plane of the top of rail on a 2 horizontal to 1 vertical slope beginning at eleven (11) feet from centerline of the nearest track, both measured perpendicular to center line of track, the Contractor must furnish the Railway five sets of working drawings showing details of construction affecting Railway Property and tracks. The working drawing must include the proposed method of installation and removal of falsework, shoring or cribbing, not included in the contract plans and two sets of structural calculations of any falsework, shoring or cribbing. For all excavation and shoring submittal plans, the current "BNSF-UPRR Guidelines for Temporary Shoring" must be used for determining the design loading conditions to be used in shoring design, and all calculations and submittals must be in accordance with the current "BNSF-UPRR Guidelines for Temporary Shoring". All submittal drawings and calculations must be stamped by a registered professional engineer licensed to practice in the state the project is located. All calculations must take into consideration railway surcharge loading and must be designed to meet American Railway Engineering and Maintenance-of-Way Association (previously known as American Railway Engineering Association) Coopers E-80 live loading standard. All drawings and calculations must be stamped by a registered professional engineer licensed to practice in the state the project is located. The Contractor must not begin work until notified by the Railway that plans have been approved. The Contractor will be required to use lifting devices such as, cranes and/or winches to place or to remove any falsework over Railway's tracks. In no case will the Contractor be relieved of responsibility for results obtained by the implementation of said approved plans.
- **1.01.08** Subject to the movement of Railway's trains, Railway will cooperate with the Contractor such that the work may be handled and performed in an efficient manner. The Contractor will have no claim whatsoever for any type of damages or for extra or additional compensation in the event his work is delayed by the Railway.

1.02 Contractor Safety Orientation

- **1.02.01 No employee of the Contractor, its subcontractors, agents or invitees may enter Railway Property without first having completed Railway's Engineering Contractor Safety Orientation, found on the web site www.BNSFContractor.com. The Contractor**

must ensure that each of its employees, subcontractors, agents or invitees completes Railway's Engineering Contractor Safety Orientation through internet sessions before any work is performed on the Project. Additionally, the Contractor must ensure that each and every one of its employees, subcontractors, agents or invitees possesses a card certifying completion of the Railway Contractor Safety Orientation before entering Railway Property. The Contractor is responsible for the cost of the Railway Contractor Safety Orientation. The Contractor must renew the Railway Contractor Safety Orientation annually. Further clarification can be found on the web site or from the Railway's Representative.

1.03 Railway Requirements

- **1.03.01** The Contractor must take protective measures as are necessary to keep railway facilities, including track ballast, free of sand, debris, and other foreign objects and materials resulting from his operations. Any damage to railway facilities resulting from Contractor's operations will be repaired or replaced by Railway and the cost of such repairs or replacement must be paid for by the Agency.
- **1.03.02** The Contractor must notify the Railway's Division Engineer _____ at (_____) _____ and provide blasting plans to the Railway for review seven (7) calendar days prior to conducting any blasting operations adjacent to or on Railway's Property.
- **1.03.03** The Contractor must abide by the following temporary clearances during construction:
 - 15'-0" Horizontally from centerline of nearest track
 - 21'-6" Vertically above top of rail
 - 27'-0" Vertically above top of rail for electric wires carrying less than 750 volts
 - 28'-0" Vertically above top of rail for electric wires carrying 750 volts to 15,000 volts
 - 30'-0" Vertically above top of rail for electric wires carrying 15,000 volts to 20,000 volts
 - 34'-0" Vertically above top of rail for electric wires carrying more than 20,000 volts
- **1.03.04** Upon completion of construction, the following clearances shall be maintained:
 - 25' Horizontally from centerline of nearest track
 - 23' 6" Vertically above top of rail
- **1.03.05** Any infringement within State statutory clearances due to the Contractor's operations must be submitted to the Railway and to the City of Corona and must not be undertaken until approved in writing by the Railway, and until the City of Corona has obtained any necessary authorization from the State Regulatory Authority for the infringement. No extra compensation will be allowed in the event the Contractor's work is delayed pending Railway approval, and/or the State Regulatory Authority's approval.
- **1.03.06** In the case of impaired vertical clearance above top of rail, Railway will have the option of installing tell-tales or other protective devices Railway deems necessary for

protection of Railway operations. The cost of tell-tales or protective devices will be borne by the Agency.

- **1.03.07** The details of construction affecting the Railway's Property and tracks not included in the contract plans must be submitted to the Railway by the City of Corona for acceptance before work is undertaken and this work must not be undertaken until approved by the Railway.
- **1.03.08** At other than public road crossings, the Contractor must not move any equipment or materials across Railway's tracks until permission has been obtained from the Railway. The Contractor must obtain a "Temporary Construction Crossing Agreement" from the Railway prior to moving his equipment or materials across the Railways tracks. The temporary crossing must be gated and locked at all times when not required for use by the Contractor. The temporary crossing for use of the Contractor will be constructed and, at the completion of the project, removed at the expense of the Contractor.
- **1.03.09** Discharge, release or spill on the Railway Property of any hazardous substances, oil, petroleum, constituents, pollutants, contaminants, or any hazardous waste is prohibited and Contractor must immediately notify the **Railway's Resource Operations Center at 1(800) 832-5452**, of any discharge, release or spills in excess of a reportable quantity. Contractor must not allow Railway Property to become a treatment, storage or transfer facility as those terms are defined in the Resource Conservation and Recovery Act or any state analogue.
- **1.03.10** The Contractor upon completion of the work covered by this contract, must promptly remove from the Railway's Property all of Contractor's tools, equipment, implements and other materials, whether brought upon said property by said Contractor or any Subcontractor, employee or agent of Contractor or of any Subcontractor, and must cause Railway's Property to be left in a condition acceptable to the Railway's representative.

1.04 Contractor Roadway Worker on Track Safety Program and Safety Action Plan:

- **1.04.01** Each Contractor that will perform work within 25 feet of the centerline of a track must develop and implement a Roadway Worker Protection/On Track Safety Program and work with Railway Project Representative to develop an on track safety strategy as described in the guidelines listed in the on track safety portion of the Safety Orientation. This Program must provide Roadway Worker protection/on track training for all employees of the Contractor, its subcontractors, agents or invitees. This training is reinforced at the job site through job safety briefings. Additionally, each Contractor must develop and implement the Safety Action Plan, as provided for on the web site www.BNSFContractor.com, which will be made available to Railway prior to commencement of any work on Railway Property. During the performance of work, the Contractor must audit its work activities. The Contractor must designate an on-site Project Supervisor who will serve as the contact person for the Railway and who will maintain a copy of the Safety Action Plan, safety audits, and Material Safety Datasheets (MSDS), at the job site.
- **1.04.02** Contractor shall have a background investigation performed on all of its employees, subcontractors and agents who will be performing any services for Railroad under this Agreement which are determined by Railroad in its sole discretion a) to be on Railroad's

property, or **b)** that require access to Railroad Critical Infrastructure, Railroad Critical Information Systems, Railroad's Employees, Hazardous Materials on Railroad's property or is being transported by or otherwise in the custody of Railroad, or Freight in Transit involving Railroad.

The required background screening shall at a minimum meet the rail industry background screening criteria defined by the e-RAILSAFE Program as outlined at www.everifile.com, in addition to any other applicable regulatory requirements.

Contractor shall obtain written consent from all its employees, subcontractors or agents screened in compliance with the e-RAILSAFE Program to participate in the Program on their behalf and to release completed background information to Railroad's designee. Contractor shall be subject to periodic audit to ensure compliance.

Contractor subject to the e-RAILSAFE Program hereunder shall not permit any of its employees, subcontractors or agents to perform services hereunder who are not first approved under e-RAILSAFE Program standards. Railroad shall have the right to deny entry onto its premises or access as described in this section above to any of Contractor's employees, subcontractors or agents who do not display the authorized identification badge issued by a background screening service meeting the standards set forth in the e-RAILSAFE Program, or who in Railroad's opinion, which may not be unreasonable, may pose a threat to the safety or security of Railroad's operations, assets or personnel.

Contractors shall be responsible for ensuring that its employees, subcontractors and agents are United States citizens or legally working in the United States under a lawful and appropriate work VISA or other work authorization.

1.05 Railway Flagger Services:

- **1.05.01** The Contractor must give Railway's **Roadmaster (telephone _____)** a minimum of thirty (30) calendar days advance notice when flagging services will be required so that the Roadmaster can make appropriate arrangements (i.e., bulletin the flagger's position). If flagging services are scheduled in advance by the Contractor and it is subsequently determined by the parties hereto that such services are no longer necessary, the Contractor must give the Roadmaster five (5) working days advance notice so that appropriate arrangements can be made to abolish the position pursuant to union requirements.
- **1.05.02** Unless determined otherwise by Railway's Project Representative, Railway flagger will be required and furnished when Contractor's work activities are located over, under and/or within twenty-five (25) feet measured horizontally from centerline of the nearest track and when cranes or similar equipment positioned beyond 25-feet from the track centerline could foul the track in the event of tip over or other catastrophic occurrence, but not limited thereto for the following conditions:
 - **1.05.02a** When, upon inspection by Railway's Representative, other conditions warrant.

- **1.05.02b** When any excavation is performed below the bottom of tie elevation, if, in the opinion of Railway's representative, track or other Railway facilities may be subject to movement or settlement.
- **1.05.02c** When work in any way interferes with the safe operation of trains at timetable speeds.
- **1.05.02d** When any hazard is presented to Railway track, communications, signal, electrical, or other facilities either due to persons, material, equipment or blasting in the vicinity.
- **1.05.02e** Special permission must be obtained from the Railway before moving heavy or cumbersome objects or equipment which might result in making the track impassable.
- **1.05.03** Flagging services will be performed by qualified Railway flaggers.
 - **1.05.03a** Flagging crew generally consists of one employee. However, additional personnel may be required to protect Railway Property and operations, if deemed necessary by the Railways Representative.
 - **1.05.03b** Each time a flagger is called, the minimum period for billing will be the eight (8) hour basic day.
 - **1.05.03c** The cost of flagger services provided by the Railway will be borne by the City of Corona. The estimated cost for one (1) flagger is approximately between \$800.00-\$1,600.00 for an eight (8) hour basic day with time and one-half or double time for overtime, rest days and holidays. The estimated cost for each flagger includes vacation allowance, paid holidays, Railway and unemployment insurance, public liability and property damage insurance, health and welfare benefits, vehicle, transportation, meals, lodging, radio, equipment, supervision and other costs incidental to performing flagging services. Negotiations for Railway labor or collective bargaining agreements and rate changes authorized by appropriate Federal authorities may increase actual or estimated flagging rates. **THE FLAGGING RATE IN EFFECT AT THE TIME OF PERFORMANCE BY THE CONTRACTOR HEREUNDER WILL BE USED TO CALCULATE THE ACTUAL COSTS OF FLAGGING PURSUANT TO THIS PARAGRAPH.**
 - **1.05.03d** The average train traffic on this route is 39 freight trains per 24-hour period at a timetable speed 60 MPH and 21 passenger trains at a timetable speed of 60 MPH.

1.06 Contractor General Safety Requirements

- **1.06.01** Work in the proximity of railway track(s) is potentially hazardous where movement of trains and equipment can occur at any time and in any direction. All work performed by contractors within 25 feet of any track must be in compliance with FRA Roadway Worker

Protection Regulations.

- **1.06.02** Before beginning any task on Railway Property, a thorough job safety briefing must be conducted with all personnel involved with the task and repeated when the personnel or task changes. If the task is within 25 feet of any track, the job briefing must include the Railway's flagger, as applicable, and include the procedures the Contractor will use to protect its employees, subcontractors, agents or invitees from moving any equipment adjacent to or across any Railway track(s).
- **1.06.03** Workers must not work within 25 feet of the centerline of any track without an on track safety strategy approved by the Railway's Project Representative. When authority is provided, every contractor employee must know: (1) who the Railway flagger is, and how to contact the flagger, (2) limits of the authority, (3) the method of communication to stop and resume work, and (4) location of the designated places of safety. Persons or equipment entering flag/work limits that were not previously job briefed, must notify the flagger immediately, and be given a job briefing when working within 25 feet of the center line of track.
- **1.06.04** When Contractor employees are required to work on the Railway Property after normal working hours or on weekends, the Railway's representative in charge of the project must be notified. A minimum of two employees must be present at all times.
- **1.06.05** Any employees, agents or invitees of Contractor or its subcontractors under suspicion of being under the influence of drugs or alcohol, or in the possession of same, will be removed from the Railway's Property and subsequently released to the custody of a representative of Contractor management. Future access to the Railway's Property by that employee will be denied.
- **1.06.06** Any damage to Railway Property, or any hazard noticed on passing trains must be reported immediately to the Railway's representative in charge of the project. Any vehicle or machine which may come in contact with track, signal equipment, or structure (bridge) and could result in a train derailment must be reported immediately to the Railway representative in charge of the project and to the Railway's Resource Operations Center at 1(800) 832-5452. Local emergency numbers are to be obtained from the Railway representative in charge of the project prior to the start of any work and must be posted at the job site.
- **1.06.07** For safety reasons, all persons are prohibited from having pocket knives, firearms or other deadly weapons in their possession while working on Railway's Property.
- **1.06.08** All personnel protective equipment (PPE) used on Railway Property must meet applicable OSHA and ANSI specifications. Current Railway personnel protective equipment requirements are listed on the web site, www.BNSFContractor.com, however, a partial list of the requirements include: a) safety glasses with permanently affixed side shields (no yellow lenses); b) hard hats; c) safety shoe with: hardened toes, above-the-ankle lace-up and a defined heel; and d) high visibility retro-reflective work wear. The Railway's representative in charge of the project is to be contacted regarding local specifications for meeting requirements relating to hi-visibility work wear. Hearing protection, fall protection, gloves, and respirators must be worn as required by State and Federal regulations. **(NOTE – Should there be a discrepancy between the information contained on the web site and the information in this paragraph, the web site will govern.)**

- **1.06.09 THE CONTRACTOR MUST NOT PILE OR STORE ANY MATERIALS, MACHINERY OR EQUIPMENT CLOSER THAN 25'-0" TO THE CENTER LINE OF THE NEAREST RAILWAY TRACK. MATERIALS, MACHINERY OR EQUIPMENT MUST NOT BE STORED OR LEFT WITHIN 250 FEET OF ANY HIGHWAY/RAIL AT-GRADE CROSSINGS OR TEMPORARY CONSTRUCTION CROSSING, WHERE STORAGE OF THE SAME WILL OBSTRUCT THE VIEW OF A TRAIN APPROACHING THE CROSSING. PRIOR TO BEGINNING WORK, THE CONTRACTOR MUST ESTABLISH A STORAGE AREA WITH CONCURRENCE OF THE RAILWAY'S REPRESENTATIVE.**
- **1.06.10** Machines or vehicles must not be left unattended with the engine running. Parked machines or equipment must be in gear with brakes set and if equipped with blade, pan or bucket, they must be lowered to the ground. All machinery and equipment left unattended on Railway's Property must be left inoperable and secured against movement. (See internet Engineering Contractor Safety Orientation program for more detailed specifications)
- **1.06.11** Workers must not create and leave any conditions at the work site that would interfere with water drainage. Any work performed over water must meet all Federal, State and Local regulations.
- **1.06.12** All power line wires must be considered dangerous and of high voltage unless informed to the contrary by proper authority. For all power lines the minimum clearance between the lines and any part of the equipment or load must be; 200 KV or below - 15 feet; 200 to 350 KV - 20 feet; 350 to 500 KV - 25 feet; 500 to 750 KV - 35 feet; and 750 to 1000 KV - 45 feet. If capacity of the line is not known, a minimum clearance of 45 feet must be maintained. A person must be designated to observe clearance of the equipment and give a timely warning for all operations where it is difficult for an operator to maintain the desired clearance by visual means.

1.07 Excavation:

- **1.07.01** Before excavating, the Contractor must determine whether any underground pipe lines, electric wires, or cables, including fiber optic cable systems are present and located within the Project work area. The Contractor must determine whether excavation on Railway's Property could cause damage to buried cables resulting in delay to Railway traffic and disruption of service to users. Delays and disruptions to service may cause business interruptions involving loss of revenue and profits. Before commencing excavation, the Contractor must contact **BNSF's Field Engineering Representative**. All underground and overhead wires will be considered HIGH VOLTAGE and dangerous until verified with the company having ownership of the line. **It is the Contractor's responsibility to notify any other companies that have underground utilities in the area and arrange for the location of all underground utilities before excavating.**
- **1.07.02** The Contractor must cease all work and notify the Railway immediately before continuing excavation in the area if obstructions are encountered which do not appear on drawings. If the obstruction is a utility and the owner of the utility can be identified, then the Contractor must also notify the owner immediately. If there is any doubt about the location of underground cables or lines of any kind, no work must be performed until the exact location has been determined. There will be no exceptions to these instructions.

- **1.07.03** All excavations must be conducted in compliance with applicable OSHA regulations and, regardless of depth, must be shored where there is any danger to tracks, structures or personnel.
- **1.07.04** Any excavations, holes or trenches on the Railway's Property must be covered, guarded and/or protected when not being worked on. When leaving work site areas at night and over weekends, the areas must be secured and left in a condition that will ensure that Railway employees and other personnel who may be working or passing through the area are protected from all hazards. All excavations must be back filled as soon as possible.

1.08 Hazardous Waste, Substances and Material Reporting:

- **1.08.01** If Contractor discovers any hazardous waste, hazardous substance, petroleum or other deleterious material, including but not limited to any non-containerized commodity or material, on or adjacent to Railway's Property, in or near any surface water, swamp, wetlands or waterways, while performing any work under this Agreement, Contractor must immediately:
(a) notify the Railway's Resource Operations Center at 1(800) 832-5452, of such discovery;
(b) take safeguards necessary to protect its employees, subcontractors, agents and/or third parties; and (c) exercise due care with respect to the release, including the taking of any appropriate measure to minimize the impact of such release.

1.09 Personal Injury Reporting

- **1.09.01** The Railway is required to report certain injuries as a part of compliance with Federal Railroad Administration (FRA) reporting requirements. Any personal injury sustained by an employee of the Contractor, subcontractor or Contractor's invitees while on the Railway's Property must be reported immediately (by phone mail if unable to contact in person) to the Railway's representative in charge of the project. The Non-Employee Personal Injury Data Collection Form contained herein is to be completed and sent by Fax to the Railway at 1(817) 352-7595 and to the Railway's Project Representative no later than the close of shift on the date of the injury.

NON-EMPLOYEE PERSONAL INJURY DATA COLLECTION

(If injuries are in connection with rail equipment accident/incident, highway rail grade crossing accident or automobile accident, ensure that appropriate information is obtained, forms completed and that data entry personnel are aware that injuries relate to that specific event.)

Injured Person Type:

- Passenger on train (C) Non-employee (N)
(i.e., emp of another railroad, or, non-BNSF emp involved in vehicle accident, including company vehicles)
- Contractor/safety sensitive (F) Contractor/non-safety sensitive (G)
- Volunteer/safety sensitive (H) Volunteer/other non-safety sensitive (I)
- Non-trespasser (D) - to include highway users involved in highway rail grade crossing accidents who did not go around or through gates
- Trespasser (E) - to include highway users involved in highway rail grade crossing accidents who went around or through gates
- Non-trespasser (J) - Off railroad property

If train involved, Train ID:

Transmit attached information to Accident/Incident Reporting Center by:

Fax 1-817-352-7595

or by Phone 1-800-697-6736

or email to: Accident-Reporting.Center@BNSF.com

Officer Providing Information:

(Name)

(Employee No.)

(Phone #)

REPORT PREPARED TO COMPLY WITH FEDERAL ACCIDENT REPORTING REQUIREMENTS AND PROTECTED FROM DISCLOSURE PURSUANT TO 49 U.S.C. 20903 AND 83 U.S.C. 490

NON-EMPLOYEE PERSONAL INJURY DATA COLLECTION

INFORMATION REQUIRED TO BE COLLECTED PURSUANT TO FEDERAL REGULATION. IT SHOULD BE USED FOR COMPLIANCE WITH FEDERAL REGULATIONS ONLY AND IT IS NOT INTENDED TO PRESUME ACCEPTANCE OF RESPONSIBILITY OR LIABILITY.

I. Accident City/St: _____ 2. Date: _____ Time: _____
County: _____ 3. Temperature: _____ 4. Weather: _____
(if non BNSF location)

Mile Post / Line Segment: _____

5. Driver's License No (and state) or other ID: _____ **SSN (required):** _____

6. Name (last, first, mi): _____

7. Address: _____ City: _____ St: _____ Zip: _____

8. Date of Birth: _____ and/or Age: _____ Gender: _____
(if available)

Phone Number: _____ Employer: _____

9. Injury: _____ 10. Body Part: _____
(i.e., Laceration, etc.) (i.e., Hand, etc.)

II. Description of Accident (To include location, action, result, etc.):

12. Treatment:

- First Aid Only
- Required Medical Treatment
- Other Medical Treatment

13. Dr. Name: _____ Date: _____

14. Dr. Address:
Street: _____ City: _____ St: _____ Zip: _____

15. Hospital Name: _____

16. Hospital Address:
Street: _____ City: _____ St: _____ Zip: _____

17. Diagnosis: _____

**REPORT PREPARED TO COMPLY WITH FEDERAL ACCIDENT REPORTING REQUIREMENTS
AND PROTECTED FROM DISCLOSURE PURSUANT TO 49 U.S.C. 20903 AND 83 U.S.C. 490**

EXHIBIT "C-1"
To Overpass Agreement
Agreement Between
BNSF RAILWAY COMPANY
and the
CONTRACTOR

Railway File: _____

Agency Project: **McKinley Street Grade Separation Project**

<%Contractor.LegalName%> (hereinafter called "Contractor"), has entered into an agreement (hereinafter called "Agreement") dated _____, 201____, with the City of Corona for the performance of certain work in connection with the following project: **BF10016433**. Performance of such work will necessarily require Contractor to enter **BNSF RAILWAY COMPANY** (hereinafter called "Railway") right of way and property (hereinafter called "Railway Property"). The Agreement provides that no work will be commenced within Railway Property until the Contractor employed in connection with said work for the City of Corona (i) executes and delivers to Railway an Agreement in the form hereof, and (ii) provides insurance of the coverage and limits specified in such Agreement and Section 3 herein. If this Agreement is executed by a party who is not the Owner, General Partner, President or Vice President of Contractor, Contractor must furnish evidence to Railway certifying that the signatory is empowered to execute this Agreement on behalf of Contractor.

Accordingly, in consideration of Railway granting permission to Contractor to enter upon Railway Property and as an inducement for such entry, Contractor, effective on the date of the Agreement, has agreed and does hereby agree with Railway as follows:

1) RELEASE OF LIABILITY AND INDEMNITY

Contractor hereby waives, releases, indemnifies, defends and holds harmless Railway for all judgments, awards, claims, demands, and expenses (including attorneys' fees), for injury or death to all persons, including Railway's and Contractor's officers and employees, and for loss and damage to property belonging to any person, arising in any manner from Contractor's or any of Contractor's subcontractors' acts or omissions or any work performed on or about Railway's property or right-of-way. **THE LIABILITY ASSUMED BY CONTRACTOR WILL NOT BE AFFECTED BY THE FACT, IF IT IS A FACT, THAT THE DESTRUCTION, DAMAGE, DEATH, OR INJURY WAS OCCASIONED BY OR CONTRIBUTED TO BY THE NEGLIGENCE OF RAILWAY, ITS AGENTS, SERVANTS, EMPLOYEES OR OTHERWISE,**

THE INDEMNIFICATION OBLIGATION ASSUMED BY CONTRACTOR INCLUDES ANY CLAIMS, SUITS OR JUDGMENTS BROUGHT AGAINST RAILWAY UNDER THE FEDERAL EMPLOYEE'S LIABILITY ACT, INCLUDING CLAIMS FOR STRICT LIABILITY UNDER THE SAFETY APPLIANCE ACT OR THE LOCOMOTIVE INSPECTION ACT, WHENEVER SO CLAIMED.

Contractor further agrees, at its expense, in the name and on behalf of Railway, that it will adjust and settle all claims made against Railway, and will, at Railway's discretion, appear and defend any suits or actions of law or in equity brought against Railway on any claim or cause of action arising or growing out of or in any manner connected with any liability assumed by Contractor under this Agreement for which Railway is liable or is alleged to be liable. Railway will give notice to Contractor, in writing, of the receipt or dependency of such claims and thereupon Contractor must proceed to adjust and handle to a conclusion such claims, and in the event of a suit being brought against Railway, Railway may forward summons and complaint or other process in connection therewith to Contractor, and Contractor, at Railway's discretion, must defend, adjust, or settle such suits and protect, indemnify, and save harmless Railway from and against all damages, judgments, decrees, attorney's fees, costs, and expenses growing out of or resulting from or incident to any such claims or suits.

In addition to any other provision of this Agreement, in the event that all or any portion of this Article shall be deemed to be inapplicable for any reason, including without limitation as a result of a decision of an applicable court, legislative enactment or regulatory order, the parties agree that this Article shall be interpreted as requiring Contractor to indemnify Railway to the fullest extent permitted by applicable law. **THROUGH THIS AGREEMENT THE PARTIES EXPRESSLY INTEND FOR CONTRACTOR TO INDEMNIFY RAILWAY FOR RAILWAY'S ACTS OF NEGLIGENCE.**

It is mutually understood and agreed that the assumption of liabilities and indemnification provided for in this Agreement survive any termination of this Agreement.

2) TERM

This Agreement is effective from the date of the Agreement until (i) the completion of the project set forth herein, and (ii) full and complete payment to Railway of any and all sums or other amounts owing and due hereunder.

3) INSURANCE

Contractor shall, at its sole cost and expense, procure and maintain during the life of this Agreement the following insurance coverage:

A. Commercial General Liability insurance. This insurance shall contain broad form contractual liability with a combined single limit of a minimum of \$5,000,000 each occurrence and an aggregate limit of at least \$10,000,000 but in no event less than the amount otherwise carried by the Contractor. Coverage must be purchased on a post 2004 ISO occurrence form or equivalent and include coverage for, but not limit to the following:

- ◆ Bodily Injury and Property Damage
- ◆ Personal Injury and Advertising Injury
- ◆ Fire legal liability
- ◆ Products and completed operations

This policy shall also contain the following endorsements, which shall be indicated on the certificate of insurance:

- ◆ The definition of insured contract shall be amended to remove any exclusion or other limitation for any work being done within 50 feet of railroad property.
- ◆ Waiver of subrogation in favor of and acceptable to Railway.
- ◆ Additional insured endorsement in favor of and acceptable to Railway.
- ◆ Separation of insureds.
- ◆ The policy shall be primary and non-contributing with respect to any insurance carried by Railway.

It is agreed that the workers' compensation and employers' liability related exclusions in the Commercial General Liability insurance policy(s) required herein are intended to apply to employees of the policy holder and shall not apply to **Railway** employees.

No other endorsements limiting coverage as respects obligations under this Agreement may be included on the policy with regard to the work being performed under this agreement.

B. Business Automobile Insurance. This insurance shall contain a combined single limit of at least \$1,000,000 per occurrence, and include coverage for, but not limited to the following:

- ◆ Bodily injury and property damage
- ◆ Any and all vehicles owned, used or hired

The policy shall also contain the following endorsements or language, which shall be indicated on the certificate of insurance:

- ◆ Waiver of subrogation in favor of and acceptable to Railway.
- ◆ Additional insured endorsement in favor of and acceptable to Railway.
- ◆ Separation of insureds.
- ◆ The policy shall be primary and non-contributing with respect to any insurance carried by Railway.

C. Workers Compensation and Employers Liability insurance including coverage for, but not limited to:

- ◆ Contractor's statutory liability under the worker's compensation laws of the state(s) in which the work is to be performed. If optional under State law, the insurance must cover all employees anyway.
- ◆ Employers' Liability (Part B) with limits of at least \$500,000 each accident, \$500,000 by disease policy limit, \$500,000 by disease each employee.

This policy shall also contain the following endorsements or language, which shall be indicated on the certificate of insurance:

- ◆ Waiver of subrogation in favor of and acceptable to Railway.

A. Railroad Protective Liability insurance naming only the **Railway** as the Insured with coverage of at least \$5,000,000 per occurrence and \$10,000,000 in the aggregate. The policy Must be issued on a standard ISO form CG 00 35 12 04 and include the following:

- ◆ Endorsed to include the Pollution Exclusion Amendment
- ◆ Endorsed to include the Limited Seepage and Pollution Endorsement.
- ◆ Endorsed to remove any exclusion for punitive damages.
- ◆ No other endorsements restricting coverage may be added.
- ◆ The original policy must be provided to the **Railway** prior to performing any work or services under this Agreement

to Property” shall be endorsed to read: “means direct and accidental loss of or damage to all property owned by any named insured and all property in any named insured’ care, custody, and control arising out of the acts or omissions of the contractor named on the Declarations.

In lieu of providing a Railroad Protective Liability Policy, Licensee may participate (if available) in Railway’s Blanket Railroad Protective Liability Insurance Policy.

Other Requirements:

Where allowable by law, all policies (applying to coverage listed above) shall contain no exclusion for punitive damages.

Contractor agrees to waive its right of recovery against **Railway** for all claims and suits against **Railway**. In addition, its insurers, through the terms of the policy or policy endorsement, waive their right of subrogation against **Railway** for all claims and suits. Contractor further waives its right of recovery, and its insurers also waive their right of subrogation against **Railway** for loss of its owned or leased property or property under Contractor’s care, custody or control.

Allocated Loss Expense shall be in addition to all policy limits for coverages referenced above.

Contractor is not allowed to self-insure without the prior written consent of **Railway**. If granted by **Railway**, any self-insured retention or other financial responsibility for claims shall be covered directly by Contractor in lieu of insurance. Any and all **Railway** liabilities that would otherwise, in accordance with the provisions of this Agreement, be covered by Contractor’s insurance will be covered as if Contractor elected not to include a deductible, self-insured retention or other financial responsibility for claims.

Prior to commencing services, Contractor shall furnish to **Railway** an acceptable certificate(s) of insurance from an authorized representative evidencing the required coverage(s), endorsements, and amendments. The certificate should be directed to the following address:

BNSF Railway Company
c/o CertFocus
P.O. Box 140528
Kansas City, MO 64114
Toll Free: 877-576-2378
Fax number: 817-840-7487
Email: BNSF@certfocus.com
www.certfocus.com

Contractor shall notify **Railway** in writing at least 30 days prior to any cancellation, non-renewal, substitution or material alteration.

Any insurance policy shall be written by a reputable insurance company acceptable to **Railway** or with a current Best's Guide Rating of A- and Class VII or better, and authorized to do business in the state(s) in which the service is to be provided.

If coverage is purchased on a "claims made" basis, Contractor hereby agrees to maintain coverage in force for a minimum of three years after expiration, cancellation or termination of this Agreement. Annually Contractor agrees to provide evidence of such coverage as required hereunder.

Contractor represents that this Agreement has been thoroughly reviewed by Contractor's insurance agent(s)/broker(s), who have been instructed by Contractor to procure the insurance coverage required by this Agreement.

Not more frequently than once every five years, **Railway** may reasonably modify the required insurance coverage to reflect then-current risk management practices in the railroad industry and underwriting practices in the insurance industry.

If any portion of the operation is to be subcontracted by Contractor, Contractor shall require that the subcontractor shall provide and maintain insurance coverage(s) as set forth herein, naming **Railway** as an additional insured, and shall require that the subcontractor shall release, defend and indemnify **Railway** to the same extent and under the same terms and conditions as Contractor is required to release, defend and indemnify **Railway** herein.

Failure to provide evidence as required by this section shall entitle, but not require, **Railway** to terminate this Agreement immediately. Acceptance of a certificate that does not comply with this section shall not operate as a waiver of Contractor's obligations hereunder.

The fact that insurance (including, without limitation, self-insurance) is obtained by Contractor shall not be deemed to release or diminish the liability of Contractor including, without limitation, liability under the indemnity provisions of this Agreement. Damages recoverable by **Railway** shall not be limited by the amount of the required insurance coverage.

In the event of a claim or lawsuit involving **Railway** arising out of this agreement, Contractor will make available any required policy covering such claim or lawsuit.

o be a separate and distinct obligation on the part of the Contractor. Therefore, these provisions shall be enforceable and Contractor shall be bound thereby regardless of whether or not indemnity provisions are determined to be enforceable in the jurisdiction in which the work covered hereunder is performed.

For purposes of this section, **Railway** shall mean “Burlington Northern Santa Fe LLC”, “BNSF Railway Company” and the subsidiaries, successors, assigns and affiliates of each.

4) SALES AND OTHER TAXES

In the event applicable sales taxes of a state or political subdivision of a state of the United States are levied or assessed in connection with and directly related to any amounts invoiced by Contractor to Railway (“Sales Taxes”), Railway shall be responsible for paying only the Sales Taxes that Contractor separately states on the invoice or other billing documents provided to Railway; *provided, however*, that (i) nothing herein shall preclude Railway from claiming whatever Sales Tax exemptions are applicable to amounts Contractor bills Railway, (ii) Contractor shall be responsible for all sales, use, excise, consumption, services and other taxes which may accrue on all services, materials, equipment, supplies or fixtures that Contractor and its subcontractors use or consume in the performance of this Agreement, (iii) Contractor shall be responsible for Sales Taxes (together with any penalties, fines or interest thereon) that Contractor fails to separately state on the invoice or other billing documents provided to Railway or fails to collect at the time of payment by Railway of invoiced amounts (except where Railway claims a Sales Tax exemption), and (iv) Contractor shall be responsible for Sales Taxes (together with any penalties, fines or interest thereon) if Contractor fails to issue separate invoices for each state in which Contractor delivers goods, provides services or, if applicable, transfers intangible rights to Railway.

Upon request, Contractor shall provide Railway satisfactory evidence that all taxes (together with any penalties, fines or interest thereon) that Contractor is responsible to pay under this Agreement have been paid. If a written claim is made against Contractor for Sales Taxes with respect to which Railway may be liable for under this Agreement, Contractor shall promptly notify Railway of such claim and provide Railway copies of all correspondence received from the taxing authority. Railway shall have the right to contest, protest, or claim a refund, in Railway’s own name, any Sales Taxes paid by Railway to Contractor or for which Railway might otherwise be responsible for under this Agreement; provided, however, that if Railway is not permitted by law to contest any such Sales Tax in its own name, Contractor shall, if requested by Railway at Railway’s sole cost and expense, contest in Contractor’s own name the validity, applicability or amount of such Sales Tax and allow Railway to control and conduct such contest.

Railway retains the right to withhold from payments made under this Agreement amounts required to be withheld under tax laws of any jurisdiction. If Contractor is claiming a withholding exemption or a reduction in the withholding rate of any jurisdiction on any payments under this Agreement, before any payments are made (and in each succeeding period or year as required by law), Contractor agrees to furnish to Railway a properly completed exemption form prescribed by such jurisdiction. Contractor shall be

1) **EXHIBIT “C” CONTRACTOR REQUIREMENTS**

The Contractor must observe and comply with all provisions, obligations, requirements and limitations contained in the Agreement, and the Contractor Requirements set forth on Exhibit “C” attached to the Agreement and this Agreement, including, but not be limited to, payment of all costs incurred for any damages to Railway roadbed, tracks, and/or appurtenances thereto, resulting from use, occupancy, or presence of its employees, representatives, or agents or subcontractors on or about the construction site. Contractor shall execute a Temporary Construction Crossing Agreement or Private Crossing Agreement (<http://www.bnsf.com/communities/fags/permits-real-estate/>), for any temporary crossing requested to aid in the construction of this Project, if approved by BNSF.

2) **TRAIN DELAY**

Contractor is responsible for and hereby indemnifies and holds harmless Railway (including its affiliated railway companies, and its tenants) for, from and against all damages arising from any unscheduled delay to a freight or passenger train which affects Railway's ability to fully utilize its equipment and to meet customer service and contract obligations. Contractor will be billed, as further provided below, for the economic losses arising from loss of use of equipment, contractual loss of incentive pay and bonuses and contractual penalties resulting from train delays, whether caused by Contractor, or subcontractors, or by the Railway performing work under this Agreement. Railway agrees that it will not perform any act to unnecessarily cause train delay.

For loss of use of equipment, Contractor will be billed the current freight train hour rate per train as determined from Railway's records. Any disruption to train traffic may cause delays to multiple trains at the same time for the same period.

Additionally, the parties acknowledge that passenger, U.S. mail trains and certain other grain, intermodal, coal and freight trains operate under incentive/penalty contracts between Railway and its customer(s). Under these arrangements, if Railway does not meet its contract service commitments, Railway may suffer loss of performance or incentive pay and/or be subject to penalty payments. Contractor is responsible for any train performance and incentive penalties or other contractual economic losses actually incurred by Railway which are attributable to a train delay caused by Contractor or its subcontractors.

The contractual relationship between Railway and its customers is proprietary and confidential. In the event of a train delay covered by this Agreement, Railway will share information relevant to any train delay to the extent consistent with Railway confidentiality obligations. The rate then in effect at the time

pursuant to this agreement.

Contractor and its subcontractors must give Railway's representative **Four (4)** weeks advance notice of the times and dates for proposed work windows. Railway and Contractor will establish mutually agreeable work windows for the project. Railway has the right at any time to revise or change the work windows due to train operations or service obligations. Railway will not be responsible for any additional costs or expenses resulting from a change in work windows. Additional costs or expenses resulting from a change in work windows shall be accounted for in Contractor's expenses for the project.

Contractor and subcontractors must plan, schedule, coordinate and conduct all Contractor's work so as to not cause any delays to any trains.

o has caused this Agreement to be executed by its duly

authorized officer the day and year first above written.



Contractor name

BNSF Railway Company

By: _____

By: _____

Printed Name: _____

Name: _____

Manager Public Projects

Title: _____

Accepted and effective this _____ day of 20__.

Contact Person: _____

Address: _____

City: _____

State: _____ Zip: _____

Fax: _____

Phone: _____

E-mail: _____

XHIBIT D
To Overpass Agreement

Cost Estimates for Railroad Work

***** MAINTAIN PROPRIETARY CONFIDENTIALITY *****

BNSF RAILWAY COMPANY
FHPM ESTIMATE FOR
CITY OF CORONA

RFA 5931321

LOCATION MAY

DETAILS OF ESTIMATE

PLAN ITEM : 236628000

VERSION : 1

PURPOSE, JUSTIFICATION AND DESCRIPTION

PIP, CAS DIV, SAN BERNARDINO SUB, LS 7602, MP 21 TO 21.5, DOT# 026519P, 5% BNSF CONTRIBUTION - INSPECTOR CORR DINATOR
REMOVE EXISTING AT GRADE XING AT MCKINLEY ST. 100% BILLABLE TO CITY OF CORONA.

REQUESTED BY ALTAGRACIA CESAIRE ON 4/5/21.
PRIMARY FUNDING SOURCE IS STATE

DESCRIPTION	QUANTITY U/M	COST	TOTAL \$
***** LABOR *****			
TOTAL LABOR COST		0	0
***** MATERIAL *****			
TOTAL MATERIAL COST		0	0
***** OTHER *****			
INSPECTOR COORDINATOR	1.0 LS	214,506	
TOTAL OTHER ITEMS COST		214,506	214,506
PROJECT SUBTOTAL			214,506
CONTINGENCIES			21,450
BILL PREPARATION FEE			2,360
GROSS PROJECT COST			238,316
LESS COST PAID BY BNSF			0
TOTAL BILLABLE COST			238,316

***** MAINTAIN PROPRIETARY CONFIDENTIALITY *****

BNSF RAILWAY COMPANY
FHPM ESTIMATE FOR
CITY OF CORONA

RFA 5927321

LOCATION MAY DETAILS OF ESTIMATE PLAN ITEM : 236630000 VERSION : 1

PURPOSE, JUSTIFICATION AND DESCRIPTION

PIP, CAS DIV. SAN BERNARDINO SUB, LS 7602, MP 21 TO 21.5, DOT# 026519P, 5% BNSF CONTRIBUTION - TRACK - CROSSING REMOVAL, REMOVE EXISTING AT GRADE CROSSING AT MCKINLEY ST. 100% BILLABLE TO CITY OF CORONA.

REQUESTED BY ALTAGRACIA CESAIRE ON 3/11/21.
PRIMARY FUNDING SOURCE IS STATE

DESCRIPTION	QUANTITY	U/M	COST	TOTAL \$
***** LABOR *****				
PLACE FIELD WELDS - CAP	256.0	MH	10,976	
REMOVE PUBLIC CROSSING	640.0	MH	25,771	
REPLACE TRACK PANELS - CAP	64.0	MH	2,577	
SURFACE TRACK - REPLACEMENT - CAP	96.0	MH	3,989	
UNLOAD BALLAST - REPLACEMENT - CAP	8.0	MH	331	
UNLOAD TRACK PANELS - REPLACEMENT	38.0	MH	1,522	
PAYROLL ASSOCIATED COSTS			29,522	
DA OVERHEADS			49,016	
EQUIPMENT EXPENSES			23,420	
INSURANCE EXPENSES			7,900	
TOTAL LABOR COST			155,024	155,024
***** MATERIAL *****				
BALLAST, FOR GENERIC USE ONLY	320.0	NT **	3,373	
PNL TRK, 40FT,136SC,8FT 6IN,PNDRL,WOOD	8.0	EA **	44,920	
RAIL, TRANSN,BE,40 FT,136 - 1/4 WORN 132	8.0	EA	7,224	
WELDKIT, GENERIC FOR ALL RAIL WEIGHTS	16.0	KT **	1,200	
MATERIAL HANDLING			2,835	
ONLINE TRANSPORTATION			4,960	
USE TAX			5,179	
OFFLINE TRANSPORTATION			671	
TOTAL MATERIAL COST			70,362	70,362
***** OTHER *****				
EQUIPMENT RENTAL	1.0	LS	25,000	
EQUIPMENT RENTAL	1.6	DAY	6,160	
TOTAL OTHER ITEMS COST			31,160	31,160
PROJECT SUBTOTAL				256,546
CONTINGENCIES				23,411
BILL PREPARATION FEE				2,800
GROSS PROJECT COST				282,757
LESS COST PAID BY BNSF				0
TOTAL BILLABLE COST				282,757

***** MAINTAIN PROPRIETARY CONFIDENTIALITY *****

BNSF RAILWAY COMPANY
FHPM ESTIMATE FOR
CITY OF CORONA

RFA 5927521

LOCATION MAY

DETAILS OF ESTIMATE

PLAN ITEM : 236627000

VERSION : 1

PURPOSE, JUSTIFICATION AND DESCRIPTION

PIP, CAS DIV, SAN BERARDINO SUB, LS 7602, MP 21 TO 21.5, DOT# 026519P, 5% BNSF CONTRIBUTION - FLAGGING SERVICES FOR MCKINLEY ST. OVERPASS. 100% BILLABLE TO CITY OF CORONA.

REQUESTED BY ALTAGRACIA CESAIRE ON 3/11/21.
PRIMARY FUNDING SOURCE IS STATE

DESCRIPTION	QUANTITY U/M	COST	TOTAL \$

LABOR			

FLAGGING - PUBLIC CROSSING - CAP	7200.0 MH	250,908	
PAYROLL ASSOCIATED COSTS		164,018	
DA OVERHEADS		272,310	
EQUIPMENT EXPENSES		55,801	
INSURANCE EXPENSES		43,908	
TOTAL LABOR COST		786,945	786,945

MATERIAL			

TOTAL MATERIAL COST		0	0

OTHER			

RENTAL VEHICLE	400.0 DAY	40,000	
TOTAL OTHER ITEMS COST		40,000	40,000
PROJECT SUBTOTAL			826,945
CONTINGENCIES			82,694
BILL PREPARATION FEE			9,097
GROSS PROJECT COST			918,736
LESS COST PAID BY BNSF			0
TOTAL BILLABLE COST			918,736

Exhibit E
To Overpass Agreement

Do Not Use

EXHIBIT F

To Overpass Agreement

Grade Separations

(FOR USE IN ANY C&M AGREEMENT FOR CONSTRUCTION OF AN OVERPASS OR AN UNDERPASS INITIATED BY A PUBLIC AGENCY)

BNSF PROCESS REQUIREMENTS FOR DESIGN & CONSTRUCTION OF GRADE SEPARATION PROJECTS BY A PUBLIC AGENCY ON BNSF RIGHT OF WAY, WHICH IMPACT BNSF PROPERTY OR OPERATIONS

1.01 General:

- 1.01.01 The Contractor must cooperate with **BNSF RAILWAY COMPANY**, hereinafter referred to as "**Railway**" where work is over or under on or adjacent to Railway property and/or right-of-way, hereafter referred to as "Railway Property", during the construction of the McKinley Street Grade Separation.
- 1.01.02 Definitions:
 - **Operationally Critical, (OC):** defined as Work that requires a submittal and acceptance by BNSF, which impacts, or could impact BNSF operations, on BNSF right-of-way or adjacent to it.
 - **Acceptance:** BNSF's response to plan submittals indicating a notice to proceed with work in the field; **Disclaimer for Acceptance: *BNSF has reviewed these submittals and no exceptions are taken with regard to BNSF's ability to use or accommodate the project as intended. BNSF has not reviewed the design details or calculations for structural integrity or engineering accuracy. BNSF accepts no responsibility for errors or omissions in the design or execution of the project.**
 - **Inspector/Coordinator, (I/C):** A third party consultant which BNSF hires to assist in the coordination of the project on BNSF's behalf. When referenced, "I/C" refers to the I/C team consisting of I/C-I, I/C-II, and the Resident Engineer (RE). The I/C team's role is to ensure the project is constructed per accepted* plans and specifications for that portion of the project on BNSF right of way, as it affects BNSF. The I/C will monitor construction activities to ensure that improvements used by BNSF meet all requirements of BNSF, and accommodate railroad operations.
- 1.01.03 The following submittals and actions are required by BNSF prior to Operationally Critical, (OC) Work being performed on BNSF property or above tracks being operated by BNSF Railway:

2.01 Submittals and Actions Required During the Project Design Phase:

- 2.01.01 The Agency shall be the main contact for BNSF throughout the project. Agency shall be included on all correspondence relating to BNSF.
- 2.01.02 Required Design Submittals: (Allow for 4 weeks for BNSF to review design submittals)

designing a grade separation which will impact BNSF Railway. Agency will be required to submit plans for BNSF review and comment. Plans shall not be labeled “final” until all comments have been addressed and BNSF has accepted* the plans.

Examples of required design submittals may be, but are not limited to:

Concept, vertical profile of Top of Rail, 30% plans and final plans

The following submittals will require a Professional Engineer, (PE) stamp:

Overpass design

Underpass design

Hydraulic study

Any non-standard design of a structure which will carry train loading

Work covered by a submittal shall not be performed in field without receiving Acceptance from BNSF.

Work windows will not exceed 6 hours, so project should be designed accordingly.

The following Disclaimer applies to BNSF acceptance of Agency design plans:

**BNSF has reviewed these submittals and no exceptions are taken with regard to BNSF's ability to use or accommodate the project as intended. BNSF has not reviewed the design details or calculations for structural integrity or engineering accuracy. BNSF accepts no responsibility for errors or omissions in the design or execution of the project.*

3.01 Submittals and Actions Required During the Construction Phase:

- 3.01.01 The Agency shall be the main contact for BNSF throughout the project. Agency shall be included on all correspondence relating to BNSF. **BNSF will NOT accept submittals directly from the Agency's Contractor.**
- 3.01.02 BNSF will hire a consultant team to perform the duties of an Inspector/Coordinator, (I/C) on behalf of BNSF for the duration of the field construction of the project. The cost of the I/C will be reimbursable to BNSF by the Agency or their Contractor.

BNSF requires the I/C team be involved in the project throughout the construction phase to represent BNSF.

r's employee from BNSF property if that employee fails to comply with the BNSF safety policy, does not have proper PPE or otherwise ignores instructions regarding work on BNSF right-of-way. The I/C has authority to shut down work on BNSF right-of-way if the contractor works in a manner that is in violation of BNSF's safety policy or FRA regulations.

Anytime instructions to the contractor by BNSF or the I/C are not complied with, the project may be shut down. All equipment and personnel will be removed from BNSF property until issues causing the shutdown are resolved to BNSF's satisfaction.

- 3.01.03 Agency must hold a pre-construction meeting with contractor and BNSF prior to work beginning on BNSF property.

The Pre-Construction meeting shall not be held until 30 days after I/C has been selected – this allows time for the I/C to become familiar with the project.

Recommend scheduling two weeks prior to construction commencing to allow for adjustment to work plans, if needed.

- 3.01.04 Required Construction Submittals: : (Allow for 4 weeks for BNSF to review submittals)

All submittals should flow from the Contractor to the Agency, to the I/C Consultant, to the BNSF Project Engineer, (PE), and to BNSF Structures with responses back through the same communication chain. **BNSF will not accept submittals directly from the Contractor.**

Any changes to the work governed by a submittal requires that the submittal be re-accepted* by BNSF before the work commences.

Examples of construction submittals required include but are not limited to:

Contractors Safety Action Plan, Fire Prevention Plan, Proposed Project Schedule, Demolition, Shoring, Falsework and Lifting of Materials.

The following submittals will require a Professional Engineer, (PE) stamp:

Critical Pick Plan (75% of capacity of crane, or multi-crane pick)

Lifted Material Plan (Placement or Removal) – When lift is within temporary construction clearances and when list is within 25' of the centerline of the nearest track

Demolition Plan

Bracing Design Plan (non-standard only per DOT)

For overpasses, Agency shall submit as-built plans of the structure, including final clearance dimensions to the I/C. Vertical clearance must be measured from the Top of Rail, horizontal clearance must be measured from the nearest track centerline.

OPERATIONALLY CRITICAL WORK AND SUBMITTALS: (4 to 6 weeks review timeline) All OC work requires a submittal and acceptance* by BNSF.

- Operationally Critical (OC) submittals are those that have the potential to affect the safe operation of trains and will need to be reviewed carefully. Work must be monitored to ensure it conforms to the submitted/accepted* plan.
 - In-person safety review meetings will be required with BNSF representative, I/C, Contractor and Agency representative for all OC work and must be documented. The purpose of the meeting is to ensure all parties understand BNSF requirements and are following the applicable submittals. When a track work window is required the meeting shall occur at least 48 hours in advance of work starting.
 - **Submittals must meet the requirements of the UP Railroad - BNSF Railway Guidelines for Railroad Grade Separation Projects. Submittals must also follow the requirements outlined in BNSF Review Comment Sheets, Use of Cranes & Lifting of Materials Submittal Schedule, BNSF Guidelines for Preparation of Bridge Demolition & Removal Plan and the BNSF-UPRR Guidelines for Temporary Shoring. Some submittals are required to be sealed by a licensed professional engineer.**
- a. See Table 3-1 for Overhead Structures in UP Railroad - BNSF Railway Guidelines for Railroad Grade Separation Projects
 - b. See Table 3-2 for Underpass Structures UP Railroad - BNSF Railway Guidelines for Railroad Grade Separation Projects
 - c. Examples of OC submittals included in the above are:
 - i. Shoring (Follow BNSF-UPRR Guidelines for Temporary Shoring)
 - ii. Falsework
 - iii. Demolition (Need plans for substructure and superstructure. Follow BNSF Guidelines for Preparation of Bridge Demolition & Removal Plan)
 - iv. Erection (overhead and underpass structures)
 - v. Construction Phasing Plans
 - d. Additional OC submittals required, but not included in the Guidelines are:
 - i. All work plans that remove tracks from service (track outage windows require a detailed Gantt chart when greater than 2 hours)
 - ii. Contingency plans
 - iii. Additional OC submittals may be required on a project by project basis.

For underpasses and other railroad bridges, as required in Sections 4.11 and 4.12 of the UP Railroad - BNSF Railway Guidelines for Railroad Grade Separation Projects, a RE will be on site full-time during construction, at

DocuSign Envelope ID: 62CB8EF2-F46B-4FDF-AD3B-ED1979049F08 , as accepted by BNSF, an I/C-I or I/C-II maybe assigned for field duties where the work is not critical to ensuring the bridge is built to accepted project plans and specification.

- BNSF requires temporary and new track and railroad bridges be inspected by an FRA qualified BNSF employee prior to being placed into service. Two week advanced notice to BNSF structures department is required. For underpasses, all pile driving records are to be provided within 3-days of driving to the BNSF PE.
- Agency shall submit an as-built survey of shoo-fly final alignments. Alignments must conform to BNSF Shoo-fly procedures.

- 3.01.05 Prior to any work commencing on BNSF right of way:

Contractors C/C-1 or Right of Entry must be fully executed and their insurance must be approved before they can perform work on BNSF property.

Proof of Contractors insurance approval must be produced to the BNSF PE and the I/C.

- 3.01.06 Contractor must adhere to all other BNSF policies and procedures not specifically mentioned in this agreement.

Exhibit G
To Overpass Agreement

McKinley Street Grade Separation Project

Estimated Total Project Cost

CONSTRUCTION

Civil Items:	\$24,400,000
Structure Items:	\$26,700,000
Railroad Items:	\$1,718,858
Construction Support:	\$11,000,000

RIGHT-OF-WAY

ROW Acquisition:	\$25,000,000
ROW Utilities:	\$2,850,000
ROW Support:	\$1,400,000

DESIGN: \$10,900,000

OTHER PROJECT SUPPORT: \$7,031,142

TOTAL PROJECT COST **\$111,000,000**