

E – General Residential Guidelines

1.	General Residential Rehabilitation Principles.....	IV-52
2.	Exterior Materials	IV-54##
3.	Windows.....	IV-54##
4.	Doors	IV-55##
5.	Porches and Stairs.....	IV-55##
6.	Ornamentation/Trim	IV-56##
7.	Roofs	IV-56##
8.	Additions to Existing Structures	IV-57##
9.	New Infill Residential Structures.....	IV-58##
10.	Accessory Buildings & Accessory Dwelling Units.....	IV-59##
11.	Secondary Residential Units	IV-59##
12.	Adaptive Reuse	IV-59##
13.	Multi-Family Residential	IV-60##
13.	Architectural Styles For New Residential.....	IV-##

The purpose of these guidelines is to help preserve and rehabilitate residential buildings and houses found within Downtown Corona neighborhoods in the RO, SF, R2, and MF districts. The guidelines are also intended to encourage require new compatible residential development with existing development and to promote the conservation and reuse of existing residences.

In general, preservation and rehabilitation efforts shall ould aim toward protecting the essential architectural features of a residential building that help to identify its individual style and thereby further its contribution to the historic character of the area.

I. General Residential Rehabilitation Principles

- a. The Rehabilitation or repair of architectural details of historic residential buildings listed on the Corona Heritage Inventory and Corona Register ~~should try~~ shall comply with Corona's Design Guidelines for Historic Buildings to retain and restore original elements. If damage or deterioration is too severe, the element should be recreated using original materials to match the design, color, texture and any other important design features.
- b. Rehabilitation of residential buildings not listed on the Corona Heritage Inventory shall incorporate architectural style that contributes to the traditional residential character of the area. ~~When replacement is necessary and original materials cannot be obtained, substitution materials should incorporate the design, color and texture that conveys the traditional visual appearance of the original material.~~

2. Exterior Materials

- a. Original exterior residential building materials ~~shall~~ be retained whenever possible. It is not desirable to use mismatched materials of different sizes, shapes, textures, or finishes.
- b. Residential buildings with original wood clapboard siding ~~shall~~ not be stuccoed in an attempt to "modernize" their appearance.
- c. Brick surfaces ~~shall~~ not be sandblasted in an attempt to remove old paint. Sandblasting will damage the natural fired surface of the brick and cause it to lose its water-repellent qualities. Paint should be removed by chemical stripping.

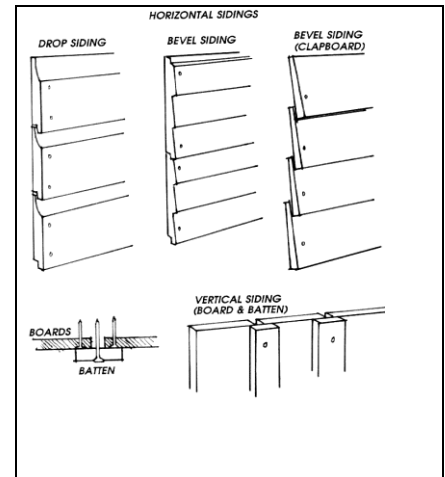

3. Windows

~~a. Historically, most older residential structures had wood framed windows that were either fixed, double hung, or casement. The size, shape and style of windows are important architectural features and the original type window should be used again.~~

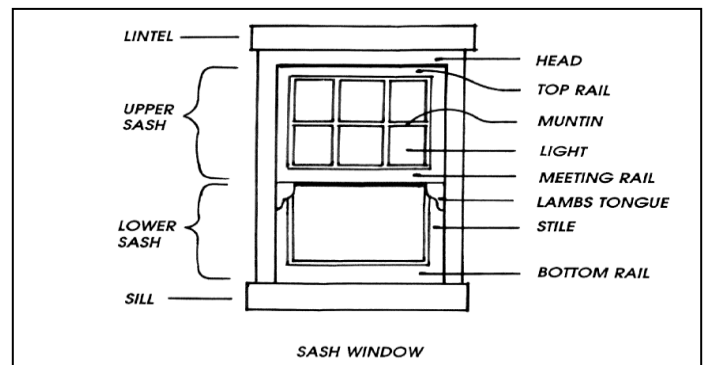

~~a.b. When window replacement is necessary, it is preferred that the new window shall be an exact match of the original size, shape and style, which may require special milling may be required.~~

~~b.e. An alternative to special milling may be the use of an "off-the-shelf" standard window that closely matches the original. While this may compromise the true architectural integrity of the building it may be an economical alternative for areas of the building that are not visible from the public right-of-way.~~

~~c.d. It is strongly recommended that aluminum frame windows shall not be used as replacements on any part of a residential structure.~~

~~d. Exterior window frames of the structure, such as the lintel, sill, and casing shall consist of the same exterior building materials used on the building.~~

4. Doors

- a. ~~Historically, residential structures had solid wood doors that fit the particular style of the building.~~ The front door of the residence was the most ornate with secondary doors usually more utilitarian in appearance. The size, shape and style of doors is an important feature of all historical architectural styles and the original type/design should be used again.
- b. If the original door is missing, select an appropriate design by studying the doors of similar residential structures in the neighborhood or consulting books on architectural styles. Many older style panel doors are still available from material suppliers and may match original doors very closely.

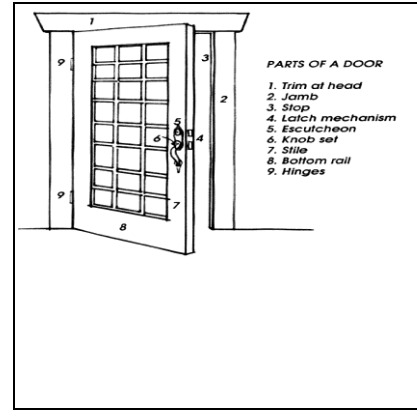

5. Porches And Stairs

- a. During rehabilitation efforts, the design integrity of the front porch ~~shall~~ not be compromised. Architectural decoration, roof form, and materials on the front entrances and porches shall be typical of the style and period of the residential structure. ~~There is often a desire to "modernize" or change the appearance of the building by changing the details of the original porch design, usually through the installation of wrought iron or aluminum railings. Temptations to change these items should be strongly avoided, as any change in the structural or decorative elements of the front porch will usually compromise the original architectural integrity of the entire building.~~

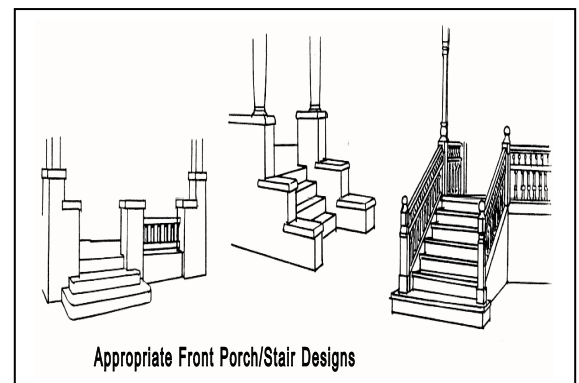
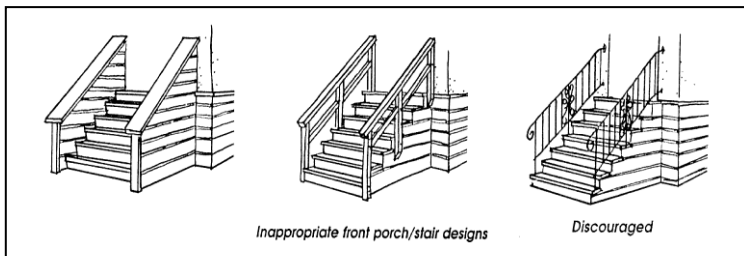

5. Porches and Stairs (continued):

- b. ~~The stairs leading to the front porch are an integral part of the overall style of the building. When stairs that~~ require rehabilitation, ~~they should~~ shall be rebuilt according to the style of the building. ~~Avoid the use of~~ Off-the-shelf, ready-made wrought iron or aluminum railings are prohibited.

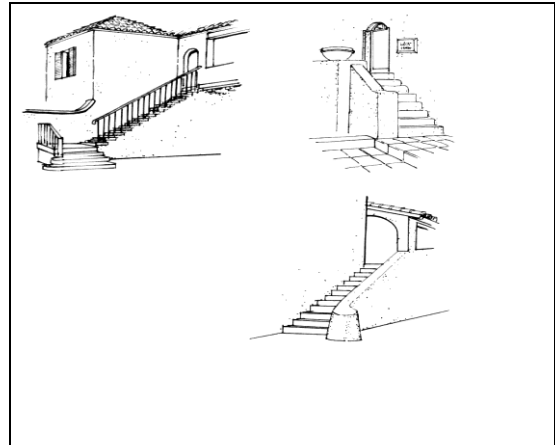

6. Ornamentation/Trim

- a. Most often it is the authentic decoration and trim on a residential structure that lends character and identifies the building with its particular architectural style. Great care should be taken in handling these materials during renovation because many times they are the very components that make a building so special.

7. Roofs

- a. Roofs are important both functionally and aesthetically. Great care should be taken to ensure that roofs are water-tight and that roofing materials are compatible with the original style of the residential structure. Often times roofs only need minor repairs but when replacement is necessary roofing materials ~~should~~ be ~~selected that are~~ appropriate to the building's architectural style.

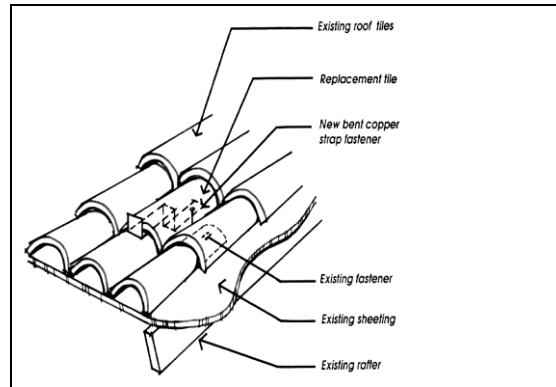

- b. The determination of what material to use for the replacement of wood shingles or shakes on historic buildings is a hard decision. The desire for the most aesthetic material is often superseded by the desire to provide maximum fire protection. Many of the In cases where wood shingles or shakes are being replaced, newer "architectural" styles of asphalt roofing (e.g. thick butt composition) that closely resemble wood shingles and provide good fire resistance shall be considered.

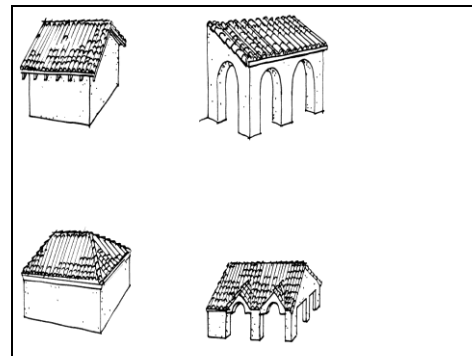

| c. Metal roofs are prohibited.

|

8. Additions to Existing Structures

a. ~~Additions to historically significant residential structures may be necessary to ensure their continued use. Modifications (e.g. additions, seismic strengthening, new entrances and exits) should be made with care so as not to compromise a residential building's historically valuable features, materials, or finishes.~~

ab. Additions should be carefully placed to minimize changes in the appearance of the residence from the street (public right-of-way). ~~It is strongly recommended that~~ additions should be placed to the side or rear of the residence and should not obstruct the original ~~the~~ appearance of the building from the street (public right-of-way). ~~If an addition is placed at the front of the residential structure, the architectural character of the addition shall be consistent with the traditional character of the area and have an integrated design with the existing residential structure.~~

b. The roof of a residential structure, especially its style, materials and pitch, is an important architectural element that must be taken into consideration when planning an addition. The roof style, pitch and materials on the addition ~~shall~~ should match the original.

cd. Adding an additional story to an existing residential structure will always change the building's proportions and ~~shall~~ should be carefully designed to follow similar two story examples of that particular architectural style found in the neighborhood. Integrating the new second story addition into the original design of the residence may be easier if the addition is setback or "stepped" back from the front facade so that it is less noticeable from the street (public right-of-way).

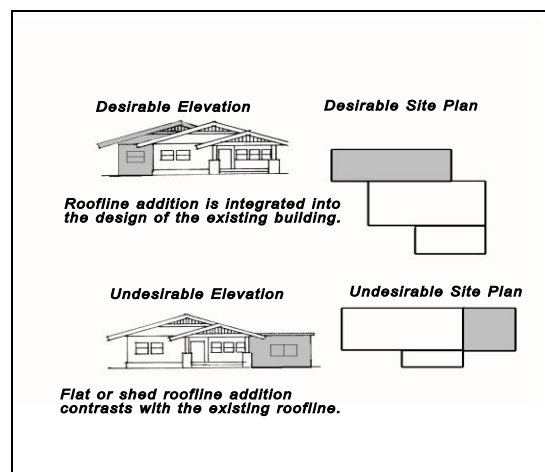
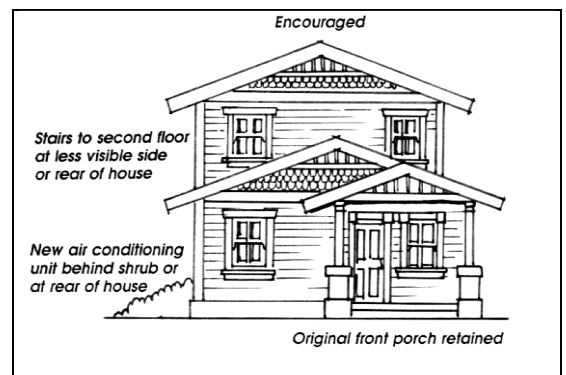
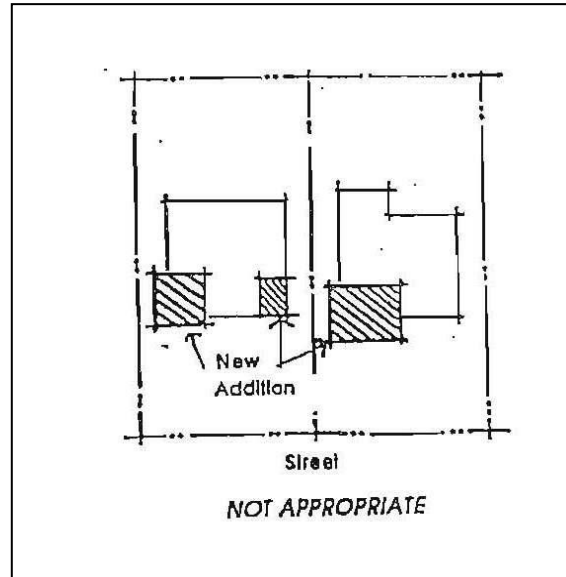

9. New Infill Residential Structures

The single most important issue of new infill residential development is one of compatibility, especially when considering larger residences. When new residential structures are developed adjacent to older single family residences, there are concerns that the height and bulk scale of the infill residences structures may have a negative impact on the adjacent smaller scale buildings. The following considerations are intended to address this concern:

a. New infill residential structures shall adhere to the architectural style provided in Section IV.E.13.

ba. New residential development shall continue the functional, on-site relationships of the surrounding neighborhood. For example, common patterns that should be continued in Corona are front porches and entries facing the street and garages/parking located at the rear of the parcel (see below).

cb. Garages in front are prohibited.

de. Front yard setbacks for new residential infill development shall match existing setback patterns of surrounding dwellings.

ed. New infill residential structures shall incorporate the traditional architectural characteristics of existing residences found in the Downtown Corona residential surrounding neighborhood, for example: window and door spacing, exterior materials, roof style and pitch, finished-floor height, porches and decoration/detail.

fe. The proper use of building materials can enhance desired neighborhood qualities such as compatibility, continuity, harmony, etc. The design of infill residential structures shall incorporate an appropriate mixture of the predominant materials found in the neighborhood. Common materials are brick, stone, wood, horizontal clapboard siding and shingles.

gf. Because nNew infill residential structures are potentially likely to be taller than one story; their height and bulk can impose on smaller adjacent residences. The height of new residential structures shall be considered within the context of surrounding residential structures. New residential structures with a greater taller height should consider setbacks or "stepping back" at the second story by at least five feet to reduce impacts on adjacent existing single story residences.

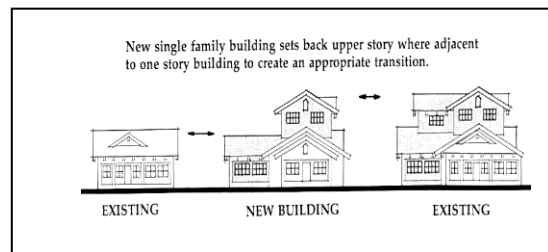

hg. The incorporation of traditional balconies, verandas and porches within the building form is strongly encouraged.

9. New Infill Residential Structures (continued):

- ih. Color schemes for infill residential structures ~~shall~~ consider the color schemes of existing residences in the surrounding neighborhood in order to maintain compatibility and harmony. Avoid sharp color contrasts with existing building colors.

10. Accessory Buildings and Accessory Dwelling Units

New accessory buildings (garages, sheds) and accessory dwelling units, second units) (living quarters) that are visible from the public right-of-way ~~shall~~ incorporate the distinctive architectural features (e.g. materials, color, roof pitch, etc.) of the main residence. Accessory dwelling units are also subject to the regulations in Corona Municipal Code Chapter 17.85. Design features should be applied with less detail on the accessory residence so that it does not compete with the main building and is clearly subordinate to it.

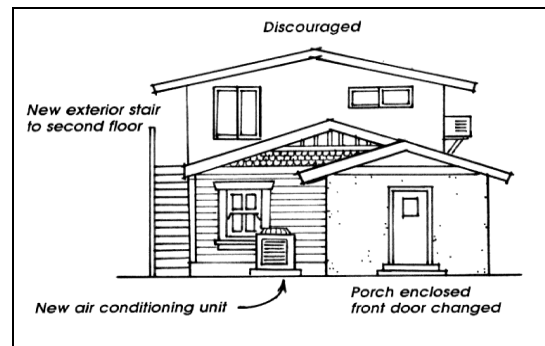

11. Secondary Residential Units

- a. ~~The entrance to an accessory dwelling should be clearly defined and recognizable as a person enters the rear yard. A ground-level patio or porch should be placed at the bottom of the stairs ascending to the dwelling. The patio or porch should be at least 50 square feet with at least six (6) feet clear in any directions. A trellis or roof should form a canopy over at least a portion of this space.~~
- b. ~~At the top of the stairs and at the entry to the unit, the landing may be extended to form a deck or balcony. The doorway to the dwelling should be accompanied by an overhang that is at least three (3) feet deep to provide protection from the rain.~~
- c. ~~The location and direction of windows should minimize the loss of privacy to adjacent residences. Windows within 10 feet of an interior property line or primary dwelling (regardless of orientation) should use clerestory windows with a sill height of at least five (5) feet.~~

12. Adaptive Reuse

The term “adaptive reuse” applies to both non-historic and historic houses and residential structures which were originally designed as residences and which are being converted (or

adapted) to a new use. Adaptive reuse is an issue in the RO-Residential Office, R-Residential, and MF- Multi-family Districts in Downtown Corona.

Adaptive reuse presents a number of special problems because the needs of the new use (such as increased parking, air conditioning, new entrances and exits, handicapped access, added floor area, etc.) are often substantially different from the old use and yet must be accommodated within the same house.

- a. The overriding principle of design for adaptive reuse is to be consistent with the significant design of the existing house or residential structure.
- b. On-site parking and driveways should be located to be unobtrusive to the historical appearance of a building from the street. Parking should be located in the back, with access from the street or an alley, if one exists. Driveways should not be “flared” at the street to provide parking in front of the home or in the front yard.

I 23. Multi-Family Residential

The purpose of the Multi-Family Residential Design Guidelines is to maintain neighborhood compatibility with other low-density neighborhoods. Multiple family housing, ~~because their higher densities,~~ tend to generate large parking areas, ~~bulkier taller~~ structures and an overall decrease in private open space. If not properly designed, these residential developments can decrease the quality of life of the established residential neighborhoods. The guidelines that follow are intended to help mitigate the negative effects of these developments and to provide a pleasant residential environment within the context of higher density. Multi-family residential in residential neighborhoods shall adhere to the architectural style provided in Section IV.E.13.

a. Multi-Family Site Design

- 1) Site setbacks of new units from public streets should continue the prevailing setback pattern unless a different setback standard is required.
- 2) New multi-family development should respect the site settings of existing properties in the immediate area through the use of similar setbacks, building arrangements, buffer yards and avoidance of overwhelming building scale and visual obstructions such as privacy walls, carports and garages.
- 3) New multi-family development shall ~~ouid~~ incorporate representative characteristics of the ~~surrounding~~ architecture used in the Downtown Corona residential neighborhood, and a positive, distinctive site layout and/or established functional pattern.
- 4) New landscaping shall ~~ouid~~ compliment existing landscape materials, location and massing on adjacent established developments where appropriate.

b. Building Placement

- 1) Clustering of multi-family units should be a consistent site planning element. Buildings composed of a series of simple yet varied plans assure compatibility and variety in overall building form.
- ~~2) Buildings should be oriented in random positions to avoid instances where living spaces of one structure face the living spaces of another and significantly reduce indoor privacy.~~
- ~~32)~~ Buildings should be oriented to maximize southern exposure to large window areas to encourage passive solar heating in the winter months.
- ~~43)~~ Buildings should be oriented in such a way as to create courtyards and open space areas, thus increasing the aesthetic appeal of the area.
- ~~54)~~ Building orientation should provide a series of public spaces for recreation and general open space.

c. Parking and Circulation

- 1) There should be no more ~~that than~~ six (6) spaces of uninterrupted parking, ~~whether in garages, carports, or on~~ open surface parking areas. Each of the six (6) spaces shall be separated from additional spaces by a landscaped bulb of a minimum width of four (4) feet ~~or diamond planter~~.
- 2) Divide large parking lots. Large parking areas should be divided into a series of connected smaller lots which are laid out in an efficient, straightforward manner.
- 3) Provide access from side streets, ~~when possible, locate access drives on side streets. When this is not possible, design the main site entry with patterned concrete or pavers to differentiate it from the public sidewalk.~~
- ~~4) Locate driveways away from street intersections. Access drives, whether located on front or side streets, should be located as far as possible from street intersections so that adequate automobile stacking space is provided.~~
- ~~54)~~ Use special accents at entries. Monumentation, special textured paving, flowering accents, walls, shrubs, and the use of specimen trees shall be used to generate visual interest at entry points.
- ~~65)~~ Screen parking lots. Utilize a 36 inch high hedge with rolling berm or 42 inch high wall to screen parking at the street periphery. (Minimum shrub container size should be five (5) gallon.)
- ~~76)~~ Carports, detached garages, and accessory structures ~~shall~~ be designed as an integral part of the architecture of the projects. These structures ~~shall~~ be similar in materials, color, and detail to the principal buildings of the development. Prefabricated metal carports are prohibited.

- 87) Parking courts should be treated as “landscape plazas” with attention to landscape surfaces, softened edges, shade and articulated pedestrian/vehicular circulation.
- 98) The parking area shall be designed in a manner which links it to the building and street sidewalk system as an extension of the pedestrian environment. This can be accomplished by using design features such as walkways with enhanced paving, trellis structures, and/or landscaping treatment.

d. Miscellaneous

- 1) Architectural screening shall be constructed of the same materials and finishes that are compatible with the adjacent building, and shall be designed and placed to compliment the building design.
- 2) Storage areas shall be completely screened from ground level ~~view~~ using appropriate materials such as solid shrub massing or ~~wood~~ walls.
- 3) Trash bins shall be located within a trash enclosure. The enclosure shall be finished using materials compatible with the surrounding architecture, and shall be softened with landscaping. Gates shall be solid metal painted to match adjacent buildings. Recommended enclosure locations include inside parking courts, or at the end of parking bays. Location of the enclosure should be conveniently accessible for trash truck access.
- 4) Where common mailbox services are provided, they should be located close to the project entry near recreational facilities. The architectural character should be similar in form, materials, and color to the surrounding buildings. Mailbox locations must be approved by the U.S. Postal Service.

13. Architectural Styles For New Residential



Throughout the Downtown Corona residential neighborhoods, pre-1950 residential structures are common. Common architectural styles for historic residential structures include Victorian, Mission and Spanish Revival, Colonial, Tudor, Bungalow and Craftsman Bungalow, and Ranch. To preserve the historic character of the Downtown Corona residential neighborhoods, the following are acceptable architectural styles that are to be used for new residential construction. These architectural styles are to be used with the General Residential Design Guidelines.

a. Architectural Styles for Downtown Corona Residential Neighborhoods

The following architectural styles and materials shall be used for new residential construction in residential neighborhoods and for residential rehabilitation projects that will extensively change the appearance of the existing residential structure. Architectural styles that are not listed in this

section but contribute to Corona's heritage and the Downtown residential neighborhood may be permitted by the Planning and Development Director.

<u>Bungalow & Craftsman</u>	<u>Common Materials</u>	<u>Common Architectural Features</u>
	<p><u>Wood</u> <u>Wood Shingles (side wall)</u> <u>Wood Clapboard</u> <u>Fieldstone</u> <u>River Rock</u> <u>Brick</u> <u>Concrete</u></p>	<ul style="list-style-type: none"> • <u>Low pitch gable or hipped roof</u> • <u>Gable dormer</u> • <u>Multiple roof planes</u> • <u>Wide eave overhang</u> • <u>Roof wall braces</u> • <u>Extended rafter tails</u> • <u>Square or rectangular form</u> • <u>Horizontal clapboard siding</u> • <u>Band casement or double-hung windows</u> • <u>Expansive open porch</u> • <u>Square or round columns and balustrades</u> • <u>Windows: mullion, muntin, sash</u> • <u>Flat roof shingles (Class A roofing required)</u>

<u>Mission and Spanish Revival</u>	<u>Common Materials</u>	<u>Common Architectural Features</u>
<p data-bbox="203 275 375 302"><u>Mission Style</u></p>  <p data-bbox="203 772 399 800"><u>Spanish Revival</u></p>  	<p data-bbox="652 275 743 302"><u>Stucco</u></p> <p data-bbox="652 310 743 338"><u>Plaster</u></p> <p data-bbox="652 346 862 373"><u>Terra Cota Tile</u></p> <p data-bbox="652 382 824 409"><u>Red Clay tile</u></p> <p data-bbox="652 417 841 445"><u>Wrought Iron</u></p> <p data-bbox="652 453 727 480"><u>Brick</u></p>	<p data-bbox="1039 275 1143 302"><u>Mission</u></p> <ul data-bbox="1089 310 1406 909" style="list-style-type: none"> <li data-bbox="1089 310 1406 453">● <u>Mission dormer or roof parapet (can be combined with low pitch roof)</u> <li data-bbox="1089 462 1406 564">● <u>Red clay barrel tile roof covering (Class A roofing required)</u> <li data-bbox="1089 573 1406 600">● <u>Overhanging eaves</u> <li data-bbox="1089 609 1406 678">● <u>Smooth stucco or plaster finish</u> <li data-bbox="1089 686 1406 789">● <u>Quatrefoil windows on mission dormer or roof parapet</u> <li data-bbox="1089 798 1406 825">● <u>Casement windows</u> <li data-bbox="1089 833 1406 909">● <u>Recessed entry over front door</u> <p data-bbox="1039 951 1240 978"><u>Spanish Revival</u></p> <ul data-bbox="1089 987 1406 1520" style="list-style-type: none"> <li data-bbox="1089 987 1406 1014">● <u>Low pitch roof</u> <li data-bbox="1089 1022 1406 1050">● <u>Cylindrical turrets</u> <li data-bbox="1089 1058 1406 1201">● <u>Terra cotta tile or red clay barrel tile roof covering (Class A roofing required)</u> <li data-bbox="1089 1209 1406 1236">● <u>Smooth stucco walls</u> <li data-bbox="1089 1245 1406 1272">● <u>Casement windows</u> <li data-bbox="1089 1281 1406 1350">● <u>Decorative iron work</u> <li data-bbox="1089 1358 1406 1386">● <u>Arched openings</u> <li data-bbox="1089 1394 1406 1470">● <u>Recessed entry over front door</u> <li data-bbox="1089 1478 1406 1520">● <u>Patio</u>
<u>Tudor</u>	<u>Common Materials</u>	<u>Common Architectural Features</u>
	<p data-bbox="625 1680 716 1707"><u>Stucco</u></p> <p data-bbox="625 1715 699 1743"><u>Brick</u></p> <p data-bbox="625 1751 699 1778"><u>Stone</u></p> <p data-bbox="625 1787 709 1814"><u>Wood</u></p>	<ul data-bbox="1057 1680 1382 1900" style="list-style-type: none"> <li data-bbox="1057 1680 1382 1749">● <u>Steeply pitched roof; side gable</u> <li data-bbox="1057 1757 1382 1785">● <u>Cross gables</u> <li data-bbox="1057 1793 1382 1900">● <u>Decorative half-timbering on wall surface</u>

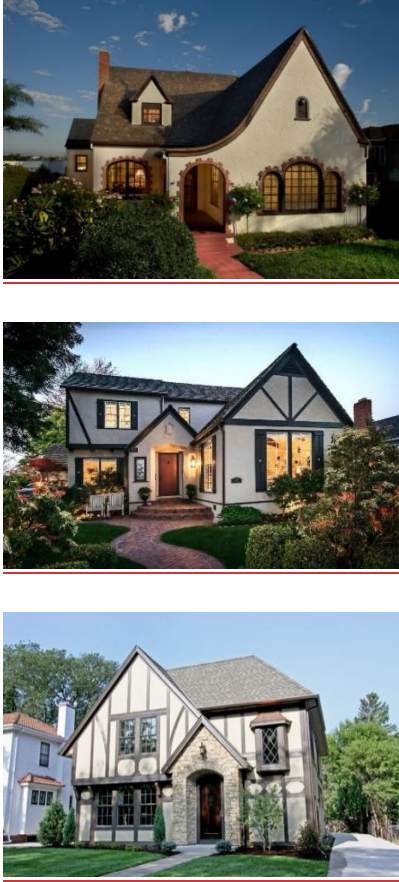
<u>Tudor</u>	<u>Common Materials</u>	<u>Common Architectural Features</u>
		<ul style="list-style-type: none"> • <u>Tall, narrow windows; multiple styles</u> • <u>Rounded arched doorway</u> • <u>Flat roof shingle (Class A roofing required)</u>

<u>Colonial Revival</u>	<u>Common Materials</u>	<u>Common Architectural Features</u>
	<p><u>Wood</u> <u>Wood Clapboard</u> <u>Brick</u> <u>Plaster</u></p>	<ul style="list-style-type: none"> • <u>Gable roof or side gable roof</u> • <u>Symmetrical window placement</u> • <u>Symmetrical façade with door in center</u> • <u>Pediment over entrance</u> • <u>Portico supported by columns</u> • <u>Covered front porch</u> • <u>Horizontal wood siding</u> • <u>Double hung window, can include muntin</u> • <u>Window lintel and sill</u>



- Flat roof shingle (Class A roofing required)

Victorian

Common Materials

Common Architectural Features



- Wood
- Wood Shingle
- Wood Clapboard
- Wood Shiplap
- Brick
- Stone

- Steeply pitched gable roof
- Decorative shingles within pitch area of roof
- Turrets can be included in roof plane
- Use of varying wall textures between floors
- Dentil molding underneath cornice
- Horizontal wood siding
- Irregular, asymmetrical massing
- Covered front porch with decorative brackets underneath roof
- Patio railing

		<ul style="list-style-type: none"> • <u>Rectangular shaped windows; double hung sashes</u> • <u>Flat roof shingle (Class A roofing required)</u>
--	--	--

<u>Ranch</u>	<u>Common Materials</u>	<u>Common Architectural Features</u>
	<p><u>Wood</u> <u>Wood Shingle</u> <u>Wood Clapboard</u> <u>Stone</u> <u>Brick</u></p>	<ul style="list-style-type: none"> • <u>Low pitch gable roof (can include dormers)</u> • <u>Cornice return underneath roof pitch</u> • <u>Wainscot or different wall textures along façade</u> • <u>Horizontal wood siding</u> • <u>Wide front porch with columns</u> • <u>Rectangular windows</u> • <u>Window side shutters</u> • <u>Window lintel and sill</u> • <u>Flat roof shingle (Class A roofing required)</u>